

Journal Pre-proof

Analyzing the energy system impacts of price-induced demand-side-flexibility with empirical data

Russell McKenna, Diana Abad Hernando, Till ben Brahim, Simon Bolwig, Jed J. Cohen, Johannes Reichl

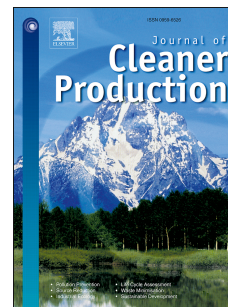

PII: S0959-6526(20)33399-0

DOI: <https://doi.org/10.1016/j.jclepro.2020.123354>

Reference: JCLP 123354

To appear in: *Journal of Cleaner Production*

Received Date: 31 March 2020

Revised Date: 24 June 2020

Accepted Date: 16 July 2020

Please cite this article as: McKenna R, Hernando DA, Brahim Tb, Bolwig S, Cohen JJ, Reichl J, Analyzing the energy system impacts of price-induced demand-side-flexibility with empirical data, *Journal of Cleaner Production*, <https://doi.org/10.1016/j.jclepro.2020.123354>.

This is a PDF file of an article that has undergone enhancements after acceptance, such as the addition of a cover page and metadata, and formatting for readability, but it is not yet the definitive version of record. This version will undergo additional copyediting, typesetting and review before it is published in its final form, but we are providing this version to give early visibility of the article. Please note that, during the production process, errors may be discovered which could affect the content, and all legal disclaimers that apply to the journal pertain.

© 2020 Elsevier Ltd. All rights reserved.

1 Analyzing the energy system impacts of price-induced
2 demand-side-flexibility with empirical data

3 Russell McKenna^{a,b}, Diana Abad Hernando^a, Till ben Brahim^a, Simon
4 Bolwig^a, Jed J. Cohen^c, Johannes Reichl^c

5 ^a*DTU Management, Technical University of Denmark, Kongens Lyngby, Denmark*

6 ^b*School of Engineering, University of Aberdeen, Aberdeen, UK*

7 ^c*Energy Institute at Johannes Kepler University, Linz, Austria*

8 **Abstract**

9 This paper assesses the potential effects on the energy system from a full
10 roll out of a smart phone app designed to connect household electricity con-
11 sumers with their consumption and price data. The effects of the app in
12 allowing greater demand-side flexibility from household consumers is esti-
13 mated based on data from an 18-month field trial involving 1,557 Austrian
14 households. These estimates are given as hourly price elasticities of electric-
15 ity demand and hourly energy efficiency treatment effects from consumer
16 engagement with the app. In a novel methodological coupling, the econo-
17 metric estimates are input into the Balmorel energy system model, which
18 is used to analyze future scenarios of full renewable energy deployment in
19 the Austrian energy system. The results demonstrate that the impact of
20 the flexible residential demand for electricity is small but significant to fu-
21 ture system costs. The total discounted system cost increases by 20-24%
22 in the renewable energy scenarios, compared to a business as usual sce-
23 nario, due to heavy investments in renewable generation. However, system
24 cost is reduced by 4-7% in renewable energy scenarios where the observed
25 demand-side flexibilities are considered. The results are subject to several
26 methodological caveats, but they give a clear signal that ICT-enabled de-
27 mand side flexibility can be an important cost-saving element that should
28 be integrated into the future energy system and considered in system-level
29 models.

30 *Keywords:* Flexible demand, Smart meters, Balmorel, Energy system
31 analysis, Energy efficiency

Sets		λ_t	Temporal fixed effect
I	Set of all households	μ_i	Fixed heterogeneity effect
R	Set of all renewable scenarios	$\epsilon_{i,t}$	Error term
S	Set of all scenarios w/o elasticity	ι_r	Intensity of treatment effect
T	Set of all time steps	$D_{i,t}$	Elec. demand
		$D_{t,r}$	Elec. demand
Parameters		Variables	
β_0	Treatment effect coefficients	$\pi_{t,s}^{el}$	Elec. price w/ large peaks
β_1	Price elasticities of electricity demand coefficients	$\pi_{t,s}^{el'}$	Elec. price w/o large peaks
$\pi_{i,t}$	Elec. price	$\pi_{t,s}^{el''}$	Elec. price w/ large peaks
$user_{i,t}$	User indicator	δ_t^π	Elec. price difference
$season_t$	Season indicator	$J_{i,t}$	Control variable for app messages
$hour_t$	Hour indicator		
$group_i$	Group indicator		

32 Nomenclature for Equations (1) to (3).

33 1. Introduction

34 In the context of rapid developments in renewable energy generation,
 35 the energy system requires increasing amounts of flexibility. One promising
 36 area lies in exploiting the flexibility on the demand side of the energy system
 37 with demand-side management (DSM) or demand-side flexibility (DSF).
 38 This idea has existed for several decades, but recently more attention has
 39 been paid to exploiting this approach in the residential sector (Bastida et al.,
 40 2019). Residential consumers are typically not exposed to short-term price
 41 differentials. Instead, the majority pay a constant price per unit of electricity
 42 consumed (Azarova et al., 2018). In order to exploit the potential for DSF in
 43 the residential sector, consumers need to be experience temporal fluctuations
 44 in electricity prices as seen on wholesale markets.

45 In our case study region of the Austrian federal state of Upper Aus-
 46 tria, consumers have the option to sign up for time of use electricity tariffs
 47 through the major utility company in the state. These consumers are then
 48 exposed to market-based fluctuations in electricity prices. To connect con-
 49 sumers with easy-to-understand information about these fluctuating prices
 50 a smart phone app was developed¹. The app forwards users' information
 51 about their electricity prices, expenditures, and consumption based on their
 52 15-min smart meter data. Thus, the app gives users the ability to change

¹For details of the PEAKapp smart phone application please visit PEAKapp.eu.

53 their behaviour in response to dynamic electricity prices and increased in-
54 formation about their own usage. The realisable potential of households to
55 shift loads from the peak times, which correspond to higher price periods,
56 to times with lower grid-wide consumption can have effects on the market
57 price and distribution costs for electricity, and stands to make renewable
58 electricity more competitive.

59 *1.1. Objectives and scope*

60 In this paper we seek to assess the potential effects that a comprehensive
61 information and communication technology (ICT) to human ecosystem, the
62 developed smart phone app, can have at the system level. Such ICT tools
63 have been shown in previous work to have the potential to influence house-
64 hold behavioural savings in energy of up to 5%, and can cause loadshifting
65 to off peak times of up to 17% of household electricity loads (Bastida et al.,
66 2019). To understand the system-wide effects of the developed app, we first
67 estimate the price responsiveness of residential electricity demand, and the
68 effects of app-supplied information on household energy efficiency. Both of
69 these quantities are estimated econometrically, using data from an Austrian
70 field trial of the developed smart phone app.

71 In the second step, the empirical estimates of price responsiveness and
72 energy efficiency are used as inputs for the Balmorel energy system model of
73 Austria to calculate the potential system effects from a large-scale rollout of
74 the app, or similar ICT tools. In the context of a scenario analysis, elastic
75 demands are derived from the field trials and employed in the model to assess
76 the system-level cost savings that might be expected from such a rollout.
77 An overview of the employed method is given in Figure 1.

78 Price elasticities are employed within this paper in order to analyze the
79 responsiveness of households to changes in electricity prices under different
80 framework conditions. Thus, a first objective of this paper is to estimate
81 the short-term price elasticities of electricity demand for the Austrian house-
82 holds participating in the field test. We estimate these elasticities for two
83 groups of participants that we term the active (A) group, those with access
84 to the app, and the control (C) group, those households without access to
85 the app. We posit that the increased access to electricity price information
86 available to those in the A group will lead to increased responsiveness to
87 price, i.e. greater magnitude price elasticities.

88 In addition to price responsiveness, we are also interested in the potential
89 for information provided in the ICT tool to influence behavioral changes
90 in household energy efficiency. A survey of 156 previous studies shows a
91 potential for information effects to decrease overall energy consumption by

92 7.4%, on average (Delmas et al., 2013). We investigate the energy efficiency
93 effects within the A group over the field trial and also analyze a subset of
94 the A group that we term heavy users, those who interact with the app
95 at least on a monthly basis over the duration of the field trial. Thus, the
96 second objective of the paper is to estimate the energy efficiency impacts of
97 the ICT to human ecosystem on household energy efficiency in the medium
98 term.

99 With the econometric estimates of price responsiveness and energy ef-
100 ficiency in hand we turn to the second stage of the analysis, namely to
101 evaluate the potential system-level impacts of our ICT tool. To this end we
102 employ an energy system model (Balmorel) that allows for a comparative
103 static analysis of the electricity market equilibrium, assuming different ag-
104 gregated consumption profiles under alternative pricing regimes. The overall
105 objective is to analyse the economic benefits to the whole Austrian energy
106 system of exploiting residential demand side flexibility and improved house-
107 hold energy efficiency at the national scale. More specifically, the objective
108 of this stage is to analyze the impact on economic, technical and environ-
109 mental indicators of a widespread exploitation of DSF via the developed
110 app.

111 *1.2. Overview*

112 This paper is structured as follows. Section 2 contains a literature review,
113 which puts this work into context and demonstrates the innovative aspects.
114 Section 3 then presents the dataset and econometric methodology to de-
115 rive the price elasticities and shows the intermediate results. Section 4 then
116 focuses on the Balmorel model, the model's extension to Austria, and the
117 scenario framework. Section 5 presents the main Balmorel results while sec-
118 tion 6 discusses the implications of the results on various technical, economic
119 and environmental criteria. Section 7 closes the paper with a summary and
120 conclusions.

121 **2. Literature review**

122 A literature review was carried out to identify research gaps and to place
123 this paper in a wider scientific context. Seventeen articles were reviewed that
124 analyse system-wide aspects of flexibility options involving energy system
125 modelling with a geographical extent from the municipal to supra-national
126 scale. All studies include analyses of DSF and several articles consider both
127 DSF and other forms of flexibility, notably distribution and/or transmission
128 networks, storage, power-to-heat, power-to-gas, and supply-side measures.

129 Features of the articles that are of relevance to this paper are the main focus
130 of this section.

131 *2.1. Previous studies of demand-side flexibility*

132 The detailed analyses of DSF are of particular interest in the present
133 context (Mishra et al., 2016; Andersen et al., 2006; Matar, 2017; Ali et al.,
134 2015; Li and Pye, 2018; Grohnheit and Klavs, 2000; Tveten et al., 2016; Katz
135 et al., 2016; Marañón-Ledesma and Tomsgard, 2019). They consider load
136 shifting (reducing demand at a given price level) or peak clipping (reduc-
137 ing peak demand where the demand appears later on), or both, for either
138 the electricity sector alone, or for both the electricity and heating sectors.
139 Five such studies (Katz et al., 2016; Mishra et al., 2016; Matar, 2017; Gils,
140 2016; Li and Pye, 2018) focus on household appliances as a DSF, includ-
141 ing automatic control of appliances (Mishra et al., 2016; Li and Pye, 2018).
142 Especially relevant here is the study by Katz et al. (2016) that compares
143 intra-hour and intra-day demand-side flexibility, corresponding to consumer
144 participation in, respectively, hourly spot (balancing) and reserve markets.
145 It concludes that consumers can gain the most by participating in reserve
146 markets where price differences are large. Several studies assess the flexibil-
147 ity of electric vehicle charging (G2V) or de-charging (V2G) (Panos et al.,
148 2019; Child et al., 2017; Pilpola et al., 2019; Sijm et al., 2019; Li and Pye,
149 2018) as potentially important DSF measures.

150 *2.2. System-level effects of flexibility*

151 Most studies identify significant system-level benefits from flexibility, in-
152 cluding lower overall system costs, less need for energy storage, higher shares
153 of renewable energy, and lower carbon emissions. In the UK, for example,
154 the use of smart appliances and passenger EVs as DSF providers leads to
155 overall cost savings of 4.6 billion GBP per year (1.03%) in 2050, due to a
156 higher penetration of (less expensive) wind power (Li and Pye, 2018). The
157 authors also identify large reductions in the marginal cost of electricity dur-
158 ing the winter (5.3%) and summer (56%) peak periods (Li and Pye, 2018).
159 The economic benefits of flexibility options in low-carbon energy scenarios
160 are often greater for the producers than for the consumers of electricity,
161 especially variable renewable energy producers (Tveten et al., 2016; Lund
162 et al., 2019). This suggests that there are important distributional issues as-
163 sociated with increasing the flexibility of energy systems (Lund et al., 2019)
164 and that households may have weak incentives to adopt flexible consumption
165 behaviours and technologies (Tveten et al., 2016).

166 2.3. Data sources

167 Only two studies (Mishra et al., 2016; Li and Pye, 2018) use experimental
168 data on energy consumption from smart meters recording consumption at
169 hourly or sub-hourly intervals as inputs to system-level modelling. All other
170 studies rely on secondary data. In this context, our paper is unique in
171 applying experimental data on household demand response in an energy-
172 system modelling framework.

173 2.4. Time resolution and time scale

174 Several studies, e.g. Katz et al. (2016), Mishra et al. (2016) and Anjo
175 et al. (2018), concern short-term (intra-day) flexibility options, typically 1-6
176 hours and up to 24 hours, such as household appliances, V2G, G2V, and
177 processes in industry and services (see Anjo et al. (2018) for an overview).
178 These analyses of DSF are based on load profiles with hourly or sub-hourly
179 resolution and covering a period from one week (Jensen et al., 2006) up to
180 one year (e.g. Gils (2016); Katz et al. (2016)). Katz et al. (2016) focus on the
181 time of day with the greatest load shift potential for household appliances,
182 the evening. Other studies, such as Panos et al. (2019), consider both short-
183 and long-term flexibility options, including batteries (daily), pumped storage
184 (weekly), power-to-gas, and seasonal power-to-heat (seasonal). Our present
185 study adds to the understanding of short-term flexibility by assessing the
186 systemic effects of ICT-enabled intra-day load shifting over a period of 18
187 months.

188 Regarding the time scale of the scenarios, ten studies cover longer peri-
189 ods, i.e. up to 2030 (e.g. Tveten et al. (2016); Child et al. (2017)), 2035 (e.g.
190 Katz et al. (2016)), and 2050 (e.g. Li and Pye (2018); Pilpola et al. (2019);
191 Lund et al. (2019)), while ‘proof-of-concept’ studies (Alhamwi et al., 2017;
192 Bolwig et al., 2018) do not specify a time period. The studies performing
193 in-depth analyses of household demand response mechanisms (Mishra et al.,
194 2016; Jensen et al., 2006; Matar, 2017; Ali et al., 2015) typically do not
195 include long-term scenarios. The exception here is Li and Pye (2018), which
196 covers the period 2010-2050, as well as the present study, which analyses
197 scenarios up to 2030.

198 2.5. Geographical scale and scope

199 The geographical scale of energy system models ranges from the supra-
200 national (e.g. Balmorel (Wiese et al., 2018), COMPETES (Sijm et al.,
201 2017)) to the national (e.g. Balmorel (Wiese et al., 2018), TIMES (Loulou
202 and Labriet, 2008), KAPSARC (King Abdullah Petroleum Studies and Re-
203 search Center (“KAPSARC”), 2020), REMix-OptiMo (Scholz et al., 2017),

204 OseMOSYS (Howells et al., 2011)) and sub-national (e.g. EnergyPLAN (De-
205 partment of Development and Planning, Aalborg University, 2020), FlexiGIS
206 (Alhamwi et al., 2018)), with a clear dominance of national-scale analyses.
207 Thirteen studies concern Northern Europe and the Baltics, while two studies
208 are from central (Switzerland) and southern Europe (Portugal) respectively,
209 and one from outside Europe (Saudi Arabia). Hence, while this article like
210 many others also addresses the national scale, it contributes to a better
211 geographical distribution of modelling flexibility across Europe.

212 2.6. *Claims of novelty and synthesis*

213 The novelty in the studies reviewed above centre on the ability to reli-
214 ably assess the system-wide effects of flexibility options over longer periods,
215 typically up to 2030-2050, regarding especially overall system costs, con-
216 sumer and producer benefits, greenhouse gas emissions, and the integration
217 of variable renewable energy technologies - especially wind, solar and hydro.
218 Often the improved analysis of flexibility involves adding modules to existing
219 energy models, soft-linking different models, or in a few cases building new
220 models. Adding new data on flexibility technologies to the models are always
221 prominent features of the studies. As in this article, about half of the studies
222 concern only DSF, often with a focus on residential DSF (appliances and
223 electric vehicles), while few address DSF in industry and services. Only two
224 such studies use experimental data but rely on estimates of potentials from
225 secondary sources. While two studies of DSF include automated controls
226 of appliances, none of the articles analyse the system-wide effects of ICT-
227 enabled DSF technologies. In summary, the central novelties in the present
228 paper are the use of primary data from a field trial, to analyze system-wide
229 flexibility potentials with a transferable methodology.

230 3. Econometric estimations and input data

231 The Austrian field study of the ICT tool involved 1,557 households as
232 participants². Smart meter electricity consumption and price data were
233 collected for these households in 15-min time slices from May 2017 until
234 October 2018. Of the 1,557 households that were recruited into the field
235 test, 1,042 were given access to the app by November 2017 and fall into
236 the A group, while 515 were not given access to the app and are denoted

²For a full explanation of the experimental design, sample composition and recruitment procedure please see Reichl et al. (2019).

237 as the C group. All participants in the A group were given access to the
238 app, but may or may not have downloaded it, or interacted with it during
239 the study period. As such, we use Google Analytics data from app usage
240 to denote a third group of participants as ‘heavy users’, who used the app
241 at least once a month over the duration of the field test (Nov. 2017 -
242 Oct. 2018). Participants in the heavy users group were exposed to the
243 information contained in the ICT tool on a regular basis over a prolonged
244 period. Amongst our sample households in the A group, 17% of them are
245 heavy users of the app based on the above definition.

246 The data were cleaned to remove readings that were obviously faulty,
247 such as meters that never registered a positive consumption value, or read-
248 ings that were unrealistically high. After the data cleaning step, the full
249 dataset contains 65,092,913 observations from May 2017 - October 2018.
250 Households in the study have various electricity tariffs (pricing plans), some
251 of which are based on a price schedule and thus can vary throughout the
252 day, while other tariffs will only adjust the price per kWh annually or semi-
253 annually. From our sample of over 65 million observations, 31.4% of them
254 are subject to time-of-use pricing. Consumption readings only from primary
255 meters are included in observed consumption values, so that secondary me-
256 ters, mostly those that govern automated systems, such as heat pumps or
257 pool cleaners, are not included here. Households are generally unable to in-
258 teract with the devices linked to secondary meters, and thus cannot change
259 the consumption on these meters in response to prices or information.

260 *3.1. Price elasticity estimation*

261 Own price elasticities are a measure of the responsiveness of demand
262 to price changes, and are expressed as the percent change in demand for a
263 good given a 1% change in the price of that good. Many past studies have
264 estimated price elasticities of demand for residential electricity consumption,
265 usually using aggregated demand data (country level, regional, etc). A
266 recent synopsis and meta-analysis of these studies finds that amongst the
267 175 estimations of short-term residential price elasticities in peer-reviewed
268 literature, the mean value is -0.228, with a minimum value of -0.948 and a
269 maximum value of 0.610 (Zhu et al., 2018). The substantial majority of these
270 estimates are less than zero, indicating that higher prices lead to a decrease
271 in quantity consumed, as would be expected by economic theory if electricity
272 is a normal good. Also notice, that the entire range of estimated elasticities is
273 less than 1 in absolute value, indicating that short term residential electricity
274 demand is relatively inelastic. Thus, we expect to find elasticities in Austria
275 that are between 0 and -1.

The general econometric strategy employed here is panel data estimation, and follows prominent papers estimating price elasticities and treatment effects on residential electricity consumption (Jessoe and Rapson, 2014; Martin and Rivers, 2018; Gilbert and Zivin, 2014). Specifically, we estimate the models in eq. (1), where the dependent variable $\log(D_{i,t})$ is the natural logarithm of the total household electricity demand for each household i in a unique 15-minute interval t .

Average Specification:

$$\log(D_{i,t}) = \beta_1 [\log(\pi_{i,t}) * \mathbf{group}_i] + \beta_2 * J_{i,t} + \lambda_t + \mu_i + \epsilon_{i,t} \quad (1)$$

Hourly Specification:

$$\log(D_{i,t}) = \beta_1 [\log(\pi_{i,t}) * \mathbf{group}_i * \mathbf{hour}_t] + \beta_2 * J_{i,t} + \lambda_t + \mu_i + \epsilon_{i,t}$$

276 The construct of interest from eq. (1) is the vector of coefficient estimates
 277 β_1 , which contains the price elasticities of demand for electricity. The Euro
 278 price per kWh of electricity is given in log form as the variable $\log(\pi_{i,t})$.
 279 Critical to our purpose is the matrix \mathbf{group}_i , which contains a set of two
 280 indicator variables denoting the experimental group to which household i
 281 belongs, either A or C. Thus, we estimate a separate price elasticity for those
 282 that have access to the app (A) and those that do not (C), simultaneously.
 283 The model in eq. (1) is specified in log-log form, for two reasons. Firstly,
 284 this ensures that both the dependent variable $\log(D_{i,t})$ approximates the
 285 normal distribution, and secondly to allow for β_1 , the price coefficients, to
 286 be easily interpreted as elasticities.

287 The μ_i terms are fixed effects at the household level, absorbing gen-
 288 eral heterogeneity in average electricity consumption between households.
 289 These terms will account for factors such as household temperature prefer-
 290 ences, appliance ownership, home size, and the number of people in the
 291 home, which are all relevant for overall electricity consumption (McKenna
 292 et al., 2016). The λ_t construct is a vector of temporal fixed effects that
 293 includes a fixed effect for each day of the sample period, and hourly fixed
 294 effects (i.e. the time resolution of Balmorel) for each day of the week. Thus,
 295 in each model we have $24 * 7$ hourly fixed effect terms that control for the
 296 average household load profile throughout each day. These are allowed to
 297 vary between days of the week since load profiles are often different between
 298 days, most notably between weekends and weekdays. The day fixed effects
 299 control for daily heterogeneity in household electricity use across the sam-
 300 ple. Sources of daily heterogeneity can include holidays, special events, and
 301 weather conditions. Since our sample is geographically contained within

302 the state of Upper Austria, sample households will be subject to generally
 303 the same weather conditions on each day, allowing the λ_t day fixed effect
 304 terms to control for this important driver of electricity use. The variable $J_{i,t}$
 305 accounts for messages that were sent out to some users of the app during
 306 points in the field test. These messages tested other potential features of
 307 the app that would allow the utility company to connect directly to their
 308 customer base. These treatments are not of primary interest here, so we
 309 simply control for their presence in the model with the $J_{i,t}$ dummy variable,
 310 which takes a value of one if a treatment message was sent out for time t
 311 to household i . The error term $\epsilon_{i,t}$ is clustered at the household level and is
 312 assumed to have a within-cluster mean of zero and normal distribution.

313 The only difference between the “Average Specification” model and the
 314 “Hourly Specification” model in eq. (1) is the interaction of a suite of indica-
 315 tors for hour of the day ($hour_t$) with the price in the Hourly Specification.
 316 This addition allows the model to estimate a separate price elasticity of
 317 demand for each hour of the day for each group (A or C). In the Hourly
 318 Specification models this results in a vector of 24 slope coefficients per group
 319 in β_1 , which relate electricity price to consumption.

320 In order to allow for sufficient variation in $\pi_{i,t}$ within panel and fixed-
 321 effect groupings, we employ fixed effects at a broader temporal scale than
 322 those used in [Martin and Rivers \(2018\)](#) and [Jesso and Rapson \(2014\)](#),
 323 and similar to the strategy taken in [Gilbert and Zivin \(2014\)](#). The problem
 324 encountered while using more flexible fixed-effect specifications that allow λ_t
 325 to also vary across households, is that within a given household, price rarely
 326 changes across days for a specific hour of the day, and price changes within
 327 days follow a schedule that does not vary strongly from day to day. Thus
 328 to identify an elasticity for each hour of the day in a given month, as is our
 329 goal, broader fixed effects terms are needed that still control for the critical
 330 factors causing household electricity consumption to vary across time, which
 331 we believe is accomplished with the specification described above.

332 The models in eq. (1) are estimated using the field test data described
 333 above. For the elasticity estimations, the dataset is limited to observations
 334 after November 21, 2017, the date when all participants in the A group had
 335 been given the link to access the app. This constrains the estimation sample
 336 to almost exactly one calendar year (Nov. 2017 - Oct. 2018) and ensures a
 337 1:1 overlap between the observations from the A and C groups in terms of the
 338 time periods observed. In total we estimate each specification of the model
 339 in eq. (1) 13 times, using a different set of data for each estimation. The
 340 first estimation uses data from the entire year, and thus results in sample
 341 average elasticity estimates across the entire time period of the sample.

342 The other 12 estimations use only data from a specific month, resulting in
343 month-specific elasticity estimations. The estimated elasticities are shown in
344 table C.2. From these elasticities the monthly estimates are those included
345 in Balmorel, while the average (full year) effects are presented in case of
346 reader interest.

347 The elasticity estimates, given in table C.2, show that the average elas-
348 ticity across the full year is -0.12 for the C group and -0.184 for the A group.
349 While the group with the app has a greater magnitude elasticity, suggesting
350 a higher degree of responsiveness to price, the elasticities are not statisti-
351 cally different between the A and C groups on average over the full year of
352 data. The interpretation of the A elasticity, for example, is that a 10% in-
353 crease in short-term price leads to a 1.84% decrease in household electricity
354 consumption. This falls within the expected range found in the synthesis of
355 elasticity estimations (Zhu et al., 2018), and also agrees with past findings
356 that the short-term electricity demand is price-inelastic.

357 Furthermore, the estimated elasticities show that the demand elasticity
358 is essentially zero during the typical sleeping hours (11pm - 7am). The elas-
359 ticity then increases in magnitude, peaking between 9 - 10am, and again
360 between 12 - 1pm, and remains large until around 4pm and then gradually
361 falling back towards zero. We note that elasticities have very low magni-
362 tudes when consumption is also low. This makes sense as most consumers
363 are sleeping at these times and unable to turn on/off household devices.
364 Comparing elasticities to average prices during a day, we note a strong neg-
365 ative correlation where times with higher prices also have greater magnitude
366 elasticities, suggesting a scale effect.

367 3.2. Energy efficiency effect estimation

368 Alongside the short-term access to price information, households with
369 access to the app also had the possibility to view detailed graphics about
370 their electricity consumption and electricity price schedules. Recent studies
371 have tested the effects of such general price and consumption information
372 on household consumption behavior. However, the reduction in energy con-
373 sumption that can be expected from additional information varies strongly
374 between studies (Buchanan et al., 2015). An empirical review of these re-
375 sults was completed in 2013, and found that the average estimated reduction
376 in household energy use from the provision of energy consumption feedback
377 was 7.4% across the 156 studies surveyed (Delmas et al., 2013). However,
378 of these 156 studies only 22 were robust to respondent socio-demographic,
379 geographic, and climate differences. The 22 robust studies showed an av-
380 erage energy reduction of 2% due to the increased information. A separate

381 review of past literature has the less optimistic finding that there may be no
 382 medium to long-term reductions in energy use from ICT-based information
 383 provision (Buchanan et al., 2015).

384 Furthermore, the type of feedback and information provided strongly in-
 385 fluences the level of energy-use-reduction achieved (Buchanan et al., 2015).
 386 In a large-scale field test in the city of Ontario, Canada, in-home displays
 387 of electricity consumption and current prices were installed by households.
 388 Households with the display decreased electricity consumption by 3.1% on
 389 average (Martin and Rivers, 2018). In a similar, yet smaller scale study in
 390 Austria it was found that providing informational feedback via ICT reduces
 391 electricity consumption by 4.5% on average amongst households (Schleich
 392 et al., 2013). Years after this Austrian field test a follow-up study was
 393 completed that found this decrease in electricity consumption was persis-
 394 tent amongst households with consumption feedback (Schleich et al., 2017).
 395 Thus, the literature in this vein suggests that finding a 0-7.4% decrease in
 396 overall electricity consumption from information effects would be reasonable.

To estimate the medium-term treatment effect of app usage on household
 electricity consumption we use a similar econometric strategy as for the
 elasticity estimation, with slight changes to account for the time-scale and
 the effect of interest.

Average Specification:

$$\log(D_{i,t}) = \beta_0 [user_{i,t} * \mathbf{season}_t] + \beta_2 * J_{i,t} + \lambda_t + \mu_i + \epsilon_{i,t} \quad (2)$$

Hourly Specification:

$$\log(D_{i,t}) = \beta_0 [user_{i,t} * \mathbf{season}_t * \mathbf{hour}_t] + \beta_1 * \log(\pi_{i,t}) + \beta_2 * J_{i,t} + \lambda_t + \mu_i + \epsilon_{i,t}$$

397 The econometric model in eq. (2) has the same elements as that in eq. (1), ex-
 398 plained in section 3.1, with the following differences. First and foremost, the
 399 construct of interest is now β_0 , which gives the average effect of app usership
 400 on consumption. This effect is broken down into seasonal energy efficiency
 401 effects through the inclusion of three season indicators in the \mathbf{season}_t ma-
 402 trix that denote winter (Dec., Jan., and Feb.), summer (June - Aug.) and
 403 transition times (March - May, Sept. - Nov.). Thus, in the Average Specifi-
 404 cation in eq. (2) we estimate three energy efficiency effects, one per season,
 405 and in the Hourly Specification we estimate $24 * 3$ energy efficiency effects.
 406 The $user_{i,t}$ variable is an indicator, which takes a value of one if household i
 407 is a ‘heavy user’ of the app during time t . Recall that a heavy user is defined
 408 as a household that used the app at least once during every month that they

409 had access to it. Also recall, that our data series begins in May 2017, but
 410 that the last households to gain access to the app did so in November 2017.
 411 Thus, for many heavy users we observe their behavior both before and af-
 412 ter they gained access to the app; once they gained access to the app the
 413 $user_{i,t}$ variable switches to one for the remainder of the sample period if the
 414 household qualifies as a heavy user. In this way, the β_0 coefficients can be
 415 thought of as ‘differences in differences’ treatment effect estimates.

416 It should be noted that we also tested a definition of the $user_{i,t}$ variable
 417 that indicated all users in the A group once they gained access to the app.
 418 However, we detect no statistically significant average energy efficiency effect
 419 on this broader group of users, likely because many of them did not use the
 420 app frequently (or at all) during the field test. As such, we narrow the
 421 definition of the $user_{i,t}$ variable to relate to the 17% of A households who
 422 were heavy users of the app. In this way we can explore the energy efficiency
 423 effects on this group who have shown an interest in energy topics and in using
 424 an ICT to human ecosystem.

425 A second change from the specification in eq. (1) to that in eq. (2) is that
 426 the λ_t construct is expanded to include *season-specific* hourly fixed effects
 427 unique to each day of the week, along with the fixed effects for each day of the
 428 sample period. Thus, in each model we have $24*7*3$ hourly fixed effect terms
 429 that control for the average household load profile throughout each day of
 430 the week for each season. This accounts for seasonal changes in electricity
 431 consumption patterns that may be present due to changing weather and
 432 hours of daylight. In the case of the elasticity estimations described in
 433 section 3.1, accounting for season-specific patterns is not critical, because
 434 the econometric inputs for Balmorel come from monthly models, which then,
 435 by default, account for seasonal effects at the finer, monthly scale within λ_t .

436 The model in eq. (2) is estimated once for the Average and once for the
 437 Hourly Specification. As noted above, these estimations use the full sample
 438 time period (May 2017 - Oct. 2018) and the full sample of available 15-min
 439 consumption observations. The results are shown in table C.1.

440 The estimated ‘treatment effects’ shown in table C.1 give the average
 441 percentage change in electricity consumption from becoming a heavy user of
 442 the app ICT tool, defined as users who engage with the app at least once per
 443 month. For example, heavy app users were able to decrease electricity con-
 444 sumption by 6-7% in the summer and transition months, on average. While
 445 in the winter months we do not find an energy efficiency effect from heavy
 446 usership of the app, on average. This could be due to the generally much
 447 higher electricity consumption in the winter cancelling out small behavioral
 448 improvements in energy efficiency (e.g. turning off the lights/appliances,

449 fewer cycles of washing machines, purchases of more efficient appliances,
450 etc.) that are identifiable under the statistical power of the study during
451 the lower consumption times of summer, autumn and spring. The hourly en-
452 ergy efficiency effects show a similar pattern to the hourly price elasticities:
453 the strongest effects are present during the day when electricity consump-
454 tion is generally high. No statistically significant energy efficiency effects
455 are observed from 8pm - 6am, when the majority of consumers are sleeping
456 and not performing active electricity consuming activities.

457 **4. Balmorel model of the Austrian energy system**

458 *4.1. Introduction to Balmorel*

459 Balmorel (BALtic Model Of Regional Electricity Liberalized) is an open-
460 source, bottom-up, partial equilibrium energy system capacity development
461 and dispatch model that employs linear programming, originally developed
462 by Ravn (2001) and subsequently extended and employed in many national
463 and international applications (e.g. Wiese et al. (2018)). Balmorel min-
464 imizes total system costs for a combined electricity and district heating
465 system in an international context in the long term, but on an hourly ba-
466 sis, including investment in new generation plants, operational costs and in
467 some cases additional transmission line capacities.

468 In the Balmorel model, as for many similar energy system models (Ringkjøb
469 et al., 2018; Keles et al., 2017; DeCarolis et al., 2017), the starting point is
470 the exogenously-defined regional demands for electricity and heat, which are
471 provided as inputs alongside macroeconomic developments in energy and
472 carbon prices. The model meets these predefined demands by employing
473 existing generation technologies, as long as technically and/or economically
474 feasible, as well as new generation plants.

475 Geographically, the model is divided into three categories: countries,
476 regions and areas. Each country is divided into a number of regions and
477 the regions are divided into areas. The model allows for electric power
478 transmission between regions via inter-connectors. Within areas, the heat
479 demand is balanced by district heating. The version of Balmorel employed
480 in this research includes the Nordics and neighbouring countries, and is
481 extended to include Austria.

482 *4.2. Scenario framework and implementation of the price elasticities in Bal- 483 morel*

484 In order to estimate the impact of a potential roll-out of the smart phone
485 app to the whole of Austria, we utilize the energy modelling framework Bal-

486 morel. The underlying hypothesis is that an energy system with high shares
 487 of variable renewable energy sources and therefore potentially more fluctu-
 488 ating electricity price profiles could benefit economically from an increase in
 489 demand side flexibility. To test this hypothesis, the following five scenarios
 490 are defined and analysed:

- 491 • Business As Usual (BAU), reflecting an expected development of the
 492 energy system with current policies
- 493 • Renewable Energy System (REN), reflecting a rapid shift to a 100%
 494 renewable energy system
- 495 • Renewable Energy System with Elastic demand (REN-E), as REN but
 496 with an elastic demand captured by the estimated price elasticities
 497 (Section 3.1)
- 498 • Renewable Energy System with Elastic demand and 17% treatment
 499 effect (REN-E-17), as REN-E but with 17% of households subject to
 500 the energy efficiency treatment effect by being heavy users of the app
 501 (Section 3.2)
- 502 • Renewable Energy System with Elastic demand and 100% treatment
 503 effect (REN-E-100), as REN-E but with 100% of households subject
 504 to the energy efficiency treatment effect by being heavy users of the
 505 app

506 The BAU scenario represents a truly descriptive approach. It takes the
 507 mainstream assumptions for e.g. fuel costs or technology characteristics
 508 into account and describes where this could lead to in the future, if nothing
 509 changes, e.g. by policy decisions. In contrast, the four renewable scenarios
 510 can be seen as artificial normative scenarios. They comply with the Austrian
 511 policy decision to de-carbonise the power system by 2030, without having
 512 introduced an additional constraint in the model. Instead, to ensure carbon-
 513 neutrality by 2030 in the model, the fossil fuel prices have been increased
 514 accordingly. Hence, the REN scenarios use an exploratory methodology.
 515 Figure 1 illustrates the employed methodology, including the five scenarios
 516 and the use of price elasticities to determine new electricity demands.

517 In the REN-E scenarios, elastic electricity demand is introduced through
 518 the price elasticities of demand estimated from the field trail, as described in
 519 Section 3. There is no balancing constraint imposed such that increases or
 520 decreases in the hourly amount of consumed electricity is compensated for
 521 in the later course of the year (i.e. no load shift). Therefore, applying the

522 elasticities likely leads to an overall change in annual household electricity
 523 consumption.

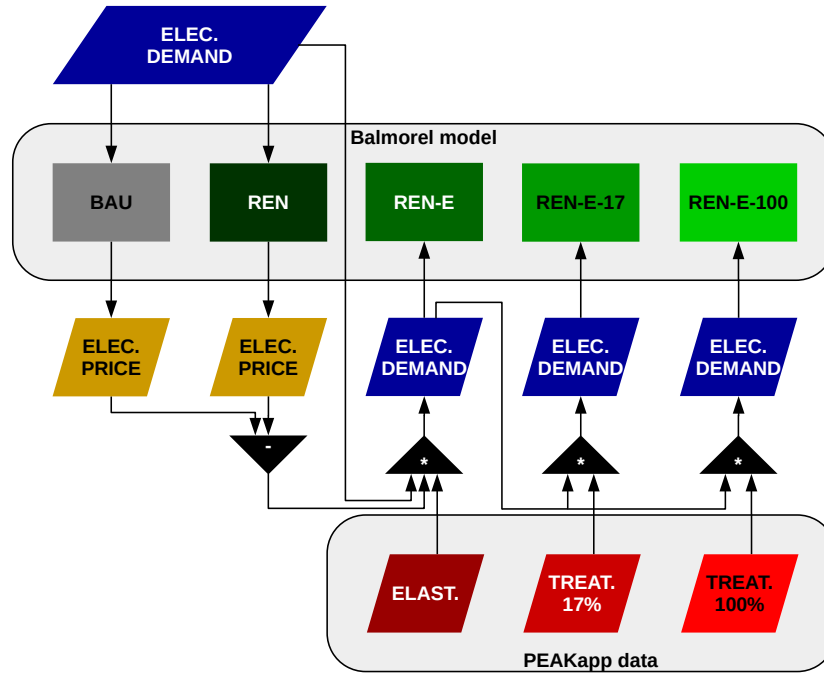

Figure 1: Conceptual illustration of the scenario setup for elasticity implementation using Balmorel (for details of the scenario framework, see text)

524 The econometric analysis of the field trial data provided hourly point
 525 estimates for price elasticity of demand as described in section 3 and shown
 526 in table C.2. Elasticities were estimated for two groups: those with and
 527 without the ICT application, called active (A) and passive (i.e. control, C)
 528 groups, respectively. The elasticities are an estimation of the household's
 529 willingness to vary electricity consumption in response to changes in price
 530 within a given hour of the day.

531 Since there is a linear dependency between price and electricity con-
 532 sumption change, their temporal resolution consists of two data points (i.e.
 533 A and C) for each hour of the day and each month of the year - in total
 534 576 data points. To derive a chronological elasticity profile for the entire
 535 year, copies of those days are concatenated to represent the full month. Af-
 536 terwards, the resulting monthly profiles, which consist entirely of copies of
 537 the one day, are again concatenated to make up a full year. This enables us

538 to multiply the electricity price differences in each hour of the year between
 539 two scenarios with the elasticity estimate for these hours. This results in
 540 an annual electricity demand change profile eq. (3). The latter can then be
 541 used to manipulate the electricity demand profiles in the successive scenario
 542 runs.

543 Equation (3) defines the mathematical implementation of the estimated
 544 elasticities (β_1 in eq. (1)) and energy efficiency treatment effects (β_0 in
 545 eq. (2)) in the different scenarios REN-E, REN-E-17, and REN-E-100.

Hourly electricity demand D by R and T :

$$D_{t,r} = D_{t,BAU} \cdot \delta_t^\pi \cdot \beta_1 (1 + \beta_0 \cdot \iota_r), \forall r \in R, \forall t \in T$$

s.t.

Hourly electricity price difference by T :

$$\delta_t^\pi = \frac{\pi_{t,REN}^{el} - \pi_{t,BAU}^{el}}{\pi_{t,BAU}^{el}}, \forall t \in T$$

Intensity of treatment effect (β_0) by R : (3)

$$\iota_{REN-E} = 0$$

$$\iota_{REN-E-17} = 0.17$$

$$\iota_{REN-E-100} = 1$$

Set of all time steps:

$$T := \{1, 2, 3, \dots, 8760\}$$

Set of all renewable scenarios w/ elasticities:

$$R := \{REN-E, REN-E-17, REN-E-100\}$$

546 4.3. Harmonizing price profiles

547 Balmorel calculates different electricity price profiles consisting of marginal
 548 or wholesale prices for each model time step. Among a number of different
 549 factors that can influence these price profiles, the setting, whether endoge-
 550 nous investments are allowed or not, and the different fuel prices in the BAU
 551 and REN scenarios showed the biggest impacts. When running the model
 552 with endogenous investments, which is the case for BAU and REN, very
 553 high price spikes are observed. These spikes correspond to the marginal
 554 electricity prices and are thus related to the investment decisions in partic-
 555 ular time steps. In contrast to the empirical elasticities employed in this

556 research, price spikes are not currently encountered for this reason (but for
 557 others) in reality, thus these two time-series need to be harmonized by re-
 558 moving these outliers. Equation (4) defines the mathematical approach to
 559 the harmonization adopted for this analysis.

Eliminating large peaks:

$$\pi_{t,s}^{el'} = \begin{cases} \bar{\pi}_{T,s}^{el} & \pi_{t,s}^{el} > \sigma(\pi_{T,s}^{el}) \\ \pi_{t,s}^{el} & \pi_{t,s}^{el} \leq \sigma(\pi_{T,s}^{el}) \end{cases} \forall t \in T, \forall s \in S$$

Re-scaling $\pi_{t,REN}^{el'}$:

$$\pi_{t,REN}^{el''} = \frac{\pi_{t,REN}^{el'} \cdot \bar{\pi}_{T,REN}^{el}}{\bar{\pi}_{T,BAU}^{el}}$$

s.t.

Electricity price profiles:

(4)

$\pi_{t,s}^{el}$: original electricity prices w/ large peaks by T and S

$\pi_{t,s}^{el'}$: electricity prices w/o large peaks by T and S

$\pi_{t,REN}^{el''}$: re-scaled electricity prices in REN w/o large peaks by T

Set of all time steps:

$$T := \{1, 2, 3, \dots, 8760\}$$

Set of all scenarios w/o elasticities:

$$S := \{BAU, REN\}$$

560 The outcome of the peak scaling procedure is shown in Figure 2. All
 561 prices greater than the standard deviation of the respective annual price
 562 profile are replaced by the annual mean prices. The new average prices are
 563 much lower than the previous spikes. This effect is resolved by re-scaling the
 564 new price profile where the peaks were eliminated, i.e. *REN w/o peaks* (see
 565 Figure 2). The re-scaling is done by taking the annual average electricity
 566 price ratio of *BAU original* (83 €/MWh) and *REN original* (102 €/MWh)
 567 of 0.8137 and multiplying the profile by it. This results in the *REN w/o*
 568 *peaks re-scaled* profile and ensures the same average annual electricity price
 569 as in *REN w/o peaks*. The former is used for the subsequent steps.

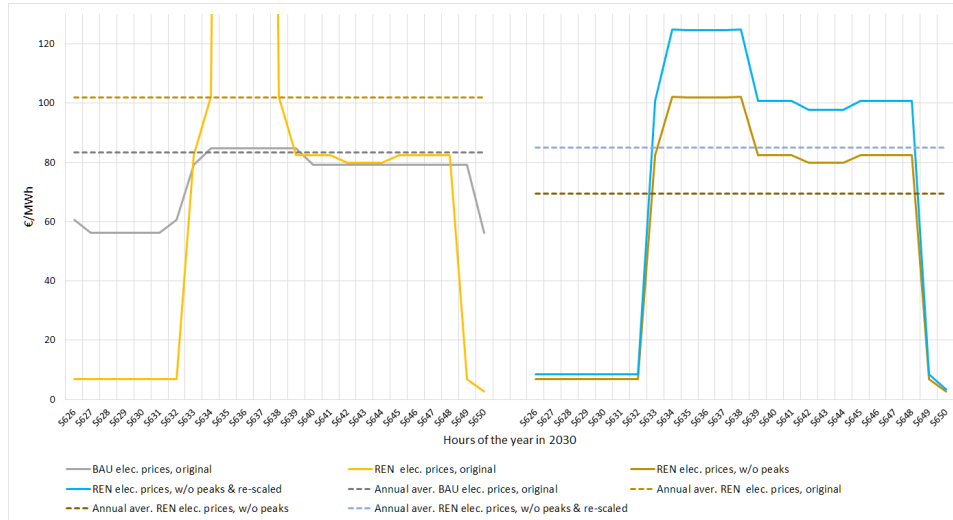

Figure 2: Example of electricity price profiles adjustments in 2030, based on eq. (4) and scenarios BAU and REN

570 5. Results of system-level analysis

571 5.1. Model validation

572 During the model development, attempts were made to ensure a close
 573 agreement with real-world data for 2016 in terms of electricity generation,
 574 international exchanges and electricity prices. For brevity, we focus here on
 575 the electricity generation in the context of an Austrian energy system with
 576 exogenously-fixed interconnector capacities and flows.

577 The validation, shown in Figure 3, focuses on a comparison of two cases,
 578 the real world based on empirical data from [E-Control \(2019\)](#) called “His-
 579 torical data” and the model of the Austrian system in isolation (with inter-
 580 connector capacities and transfers exogenously fixed) called “Balmorel re-
 581 sults”.

582 In the base year, the existing power plant capacity is fixed. Due to this,
 583 the focus is on the amount of electricity by fuel and technology in this base
 584 year. Figure 3 shows the generation by fuel type and generally illustrates a
 585 close agreement between both cases, especially for coal, hydro-power, solar
 586 energy and wind. There is substantially more deviation between these two
 587 cases for the generation from wood-chips, due to uncertainties in the assumed
 588 fuel price - this is at least partly compensated by higher coal generation in
 589 the Balmorel results.

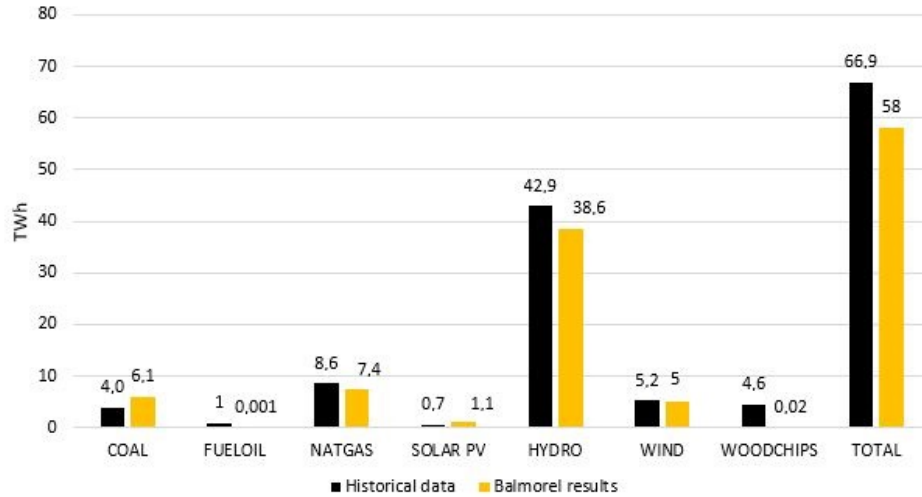

Figure 3: Comparison of electricity generation by fuel from Balmorel in 2016 with historical data based on [E-Control \(2019\)](#).

590 Overall, then, we encountered results in terms of generation that are
 591 broadly aligned with those seen in reality. The RMSE of the Balmorel
 592 results compared to the historical data across all fuel types is 11 TWh,
 593 which is a reasonable precision for a model of this type.

594 5.2. Capacity

595 Figure 4 shows the endogenous and exogenous generation capacities in
 596 2030 for the five analyzed scenarios. The BAU scenario has substantial in-
 597 vestments in solar PV (14.5 GW) and onshore wind (2.7 GW), and the low-
 598 est investments in electric battery storage (4 GW), which is incentivized by
 599 very high fossil fuel prices. This scenario is also the only one with additional
 600 gas-fired combined heat and power (CHP-extraction) capacity investments
 601 (1 GW), since the fossil fuel prices are kept almost constant in this scenario
 602 as shown in [Appendix A](#). In contrast to the BAU, the REN scenario repre-
 603 sents a completely renewable energy system, with substantially more solar
 604 PV (16.4 GW), wind (5.5 GW) and electrical storage (11.4 GW) than in the
 605 BAU scenario, but equal amounts of hydropower, due to the fact that this
 606 capacity is exogenously fixed.

607 The first scenario with the price elasticities but no energy efficiency treat-
 608 ment effect (REN-E, Figure 4) has even more installed capacity, which is
 609 due to increased solar PV (16.9 GW), wind (5.9 GW) and battery storage
 610 (12.2 GW) technologies. The treatment effect involving 17% heavy users

611 encountered in the context of the field trials leads to a very slight capacity
 612 reduction compared to scenario REN-E, again mainly relating to onshore
 613 wind and PV, with a small increase in storage capacity. Finally, in the
 614 scenario assuming 100% heavy users in the Austrian population who are
 615 subject to the estimated energy efficiency treatment effects, a more substan-
 616 tial reduction in capacity is encountered compared to the REN-E scenario,
 617 especially in solar PV (15.9 GW), wind (5.7 GW) and storage (12.0 GW)
 618 technologies.

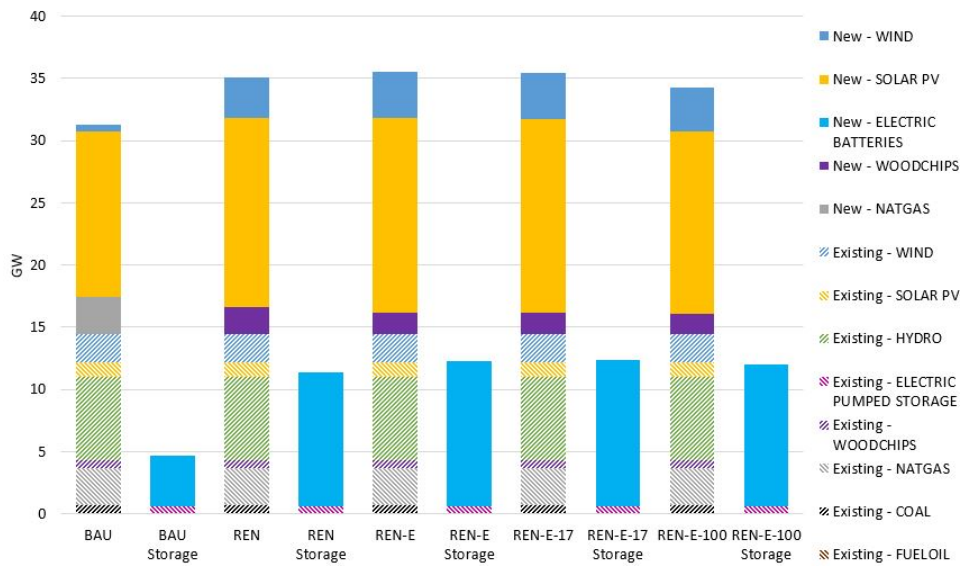

Figure 4: Endogenous (New) and exogenous (Existing) generation capacity in 2030 for the five analyzed scenarios.

619 5.3. Generation, fuel use and emissions

620 Figure 5 below shows the total electricity generation by fuels for the five
 621 analyzed scenarios. The total generation in BAU amounts to 67 TWh, which
 622 increases marginally in the REN scenario to 67.2 TWh, before reducing to
 623 66.7, 66.5 and 65.4 TWh in the REN-E, REN-E-17 and REN-E-100 scenar-
 624 ios respectively. The main differences in generation source occur in moving
 625 between the BAU and REN scenarios, in which natural gas generation is
 626 mainly displaced by a combination of woodchips and other renewables (as
 627 also demonstrated for capacity in Figure 4). The main reason for slightly

628 higher generation in the REN scenarios is the exploitation of storage tech-
 629 nologies with a full-cycle efficiency of less than 100%.

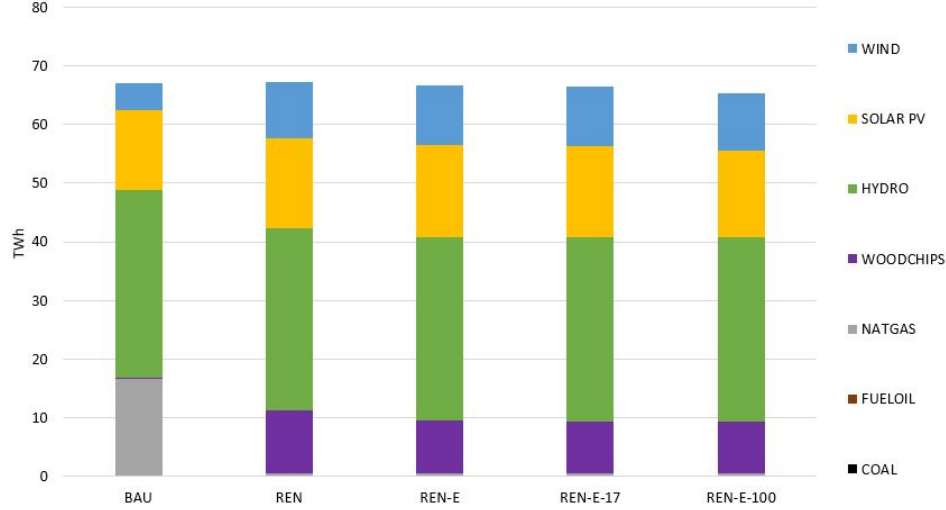

Figure 5: Electricity generation by fuel type in 2030 for the five analyzed scenarios.

630 The annual CO₂ emissions in the five analysed scenarios are shown in
 631 Table 1. According to these results, the annual CO₂ emissions amount to
 632 about 5.7 Mt CO₂ in the BAU, consisting mainly of emissions from natural
 633 gas and small amounts of coal and fuel oil. The emissions in all four of
 634 the other scenarios are substantially lower, in the range 0.15-0.16 Mt CO₂
 635 (i.e. 3% of the BAU). Amongst the renewable scenarios, the REN scenario
 has the lowest emissions. Introducing the elasticities into the model results

Table 1: Annual CO₂ emissions in the five analyzed scenarios [Mt CO₂]

fuel type/scenario	BAU	REN	REN-E	REN-E-17	REN-E-100
Coal	86.3	1.1	3.2	2.9	2.2
Natural gas	5610.2	147.8	163.7	160.8	152.0
Fuel oil	0.04				
Total	5696.54	148.9	166.9	163.7	154.2

636 in the need for more flexible generation, and therefore increases the over-
 637 all emissions in REN-E. The introduction of the treatment effects in the
 638

639 subsequent scenarios seems to have a linear effect on the reduction of the
 640 emissions – but even with a 100% treatment effect, the emissions do not
 641 reach the same level as in the REN scenario.

642 5.4. Objective function

643 Figure 6 below shows the difference in the objective function value (i.e.
 644 overall total discounted system costs) relative to the BAU scenario. As ex-
 645 pected, the highly-renewable scenarios result in substantially higher system
 646 costs than the BAU scenario, by around 24% in the case of REN. The in-
 647 troduction of the elasticities in scenario REN-E and the subsequent heavy
 648 users (in REN-E-17 and REN-E-100) reduce the overall system costs, to a
 649 minimum of 20% higher than BAU in the case of the REN-E-100 scenario.



Figure 6: Objective function values for total system discounted costs in the four renewable scenarios relative to the BAU scenario

650 All of the renewable scenarios benefit from a reduction in CO₂ costs,
 651 reflecting the complete elimination of all non-renewable generation by 2030
 652 due to prohibitively high fossil fuel prices. Additional costs are mainly
 653 concentrated in the capital cost fraction, due to the additional required
 654 investment in renewable generation plants, especially wind and PV.

655 *5.5. Sensitivity analysis*

656 In order to better understand the model's behaviour towards the intro-
 657 duction of elasticities, we investigate the following results with regard to
 658 their sensitivity to change: 1) objective values; 2) total investments in elec-
 659 tricity generation capacity; 3) total annual electricity demand profiles. In
 660 the course of this analysis, the elasticity profiles are multiplied by factors
 661 from 0.5 (-50%) to 1.5 (+50%) in steps of 0.1. With the resulting elasticity
 662 profiles, new demand profiles are derived as input to the REN-E scenario.

663 As shown in Figure 7, the relation between elasticity and objective value
 664 change is linear and inversely proportional. However, the total impact seems
 665 rather small and there is no threshold identifiable. An increase in the short-
 666 term price elasticity of electricity demand therefore holds potential for pos-
 667 itive socio-economic effects in terms of cost savings at the system level.

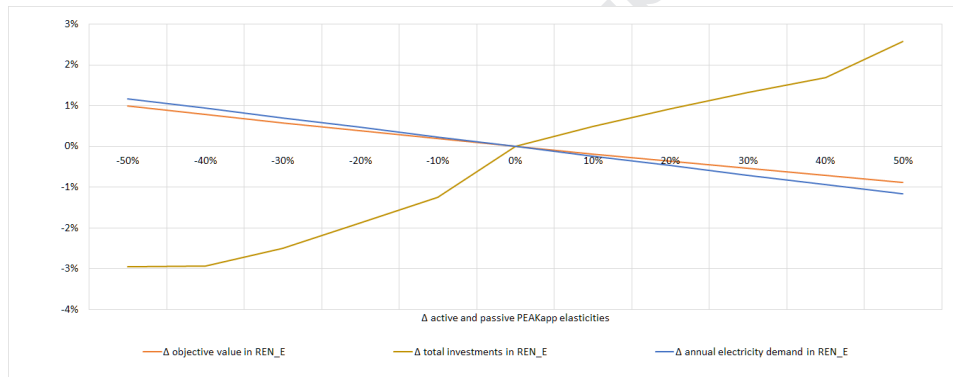

Figure 7: Sensitivity of the objective value, total capacity investment and electricity demand in the REN-E scenario compared to BAU in 2030.

668 An ascending, rather flat s-shape can be recognized for the total capacity
 669 investments. In our case, more elasticities entail lower total system costs by
 670 means of increasing investments into PV and battery capacity at relatively
 671 low costs. This can be explained by the demand peaks in hours where the
 672 prices as well as the demands are at high levels, which only occurs during
 673 daytime hours.

674 The relation between changing elasticities and total electricity demands
 675 follows a strong linear, inversely proportional trend. Again, the impact of the
 676 change stays relatively small and it does not show a threshold at any point.
 677 Overall, the results and trends of this analysis are as expected regarding
 678 the objective values and electricity demands, however with relatively small
 679 impacts.

680 **6. Discussion**

681 *6.1. Discussion of results*

682 The results show that increased DSF in the Austrian residential sector
683 can provide the electricity system with benefits such as lower fuel use, lower
684 overall and peak demands, a more efficient integration of renewable energies
685 through lower total generation and storage capacities, and therefore lower
686 total system costs. Overall, the trend towards an overall higher generation
687 capacity in the REN scenario continues when flexible demand in the form of
688 elasticities are introduced. The treatment/learning effect then reduces the
689 required capacity as it tends to reduce also the peak demand and therefore
690 the amount of secured capacity that is required to maintain security of sup-
691 ply. Two effects are observable in the results, namely the general flexibility
692 through elastic demand and the energy efficiency effect encountered with
693 heavy users of the app. Within the analytical framework employed here,
694 the impact of both effects can be quantified and better understood in the
695 broader context of the Austrian national energy system.

696 As seen in the previous section, the impacts of the elastic demand in-
697 troduced in the REN-E scenario are small but significant. Compared to the
698 renewable scenario with inelastic demand (REN), the system-wide flexibility
699 introduced by connecting all residential consumers with their electricity price
700 data through a smart phone app could reduce the overall system costs by
701 2.6%. Further reductions in system-level costs could be realized by achieving
702 a high proportion of heavy users of the app who engage with their energy
703 information at least monthly and improve their behavioral energy efficiency
704 as a result. This is demonstrated at the system level in the REN-E-17 and
705 REN-E-100 scenarios, where the impact of 17% and 100% of users qualifying
706 as heavy app users is evaluated. In these two cases, additional cost savings
707 compared to the REN-E scenario are 0.24% and 1.29%, respectively. This
708 implies that a national roll out of an ICT to human ecosystem in electricity
709 provision to all households in Austria could bring substantial costs savings
710 in terms of avoided investments, fuel costs and more efficient integration of
711 renewable energy, and that these savings are magnified as more households
712 engage with the ICT system and critically evaluate their own electricity
713 consumption behavior.

714 Although the economic benefits to the system increase with higher elas-
715 ticities, this comes with a slightly negative impact on the environmental
716 performance, due to different fuel utilization. This is in contrast to other
717 studies, e.g. [Li and Pye \(2018\)](#). Another study employing the Balmorel
718 model and an add-in to consider the techno-economic characteristics of load

719 shifting potentials found similar results for the Nordic and Baltic region.
720 Although they do not explicitly derive price elasticities, the authors identify
721 a peak reduction of between 1% and 7% excluding and including electrical
722 heating applications respectively (Kirkerud et al., 2019).

723 In the context of this analysis, these total discounted cost savings are of
724 the order of €60 million annually, based on the above-mentioned differences
725 between the REN and REN-E-100 scenarios, respectively. These figures
726 should be put into context of the broader cost implications of this roll out.
727 The smart phone app utilized in this research was developed by a special-
728 ized software company with the ambition to serve as an interface between
729 an electricity supplier and its clients, potentially for millions of household
730 customers. The development of the app built on an existing well-functioning
731 app system for displaying smart metered electricity consumption, which at
732 that time did not have the functionalities for handling dynamic electric-
733 ity prices and informing households about their current consumption levels.
734 The effort to develop and test these functionalities accumulated to about
735 two person years of programming work. In addition to the development of
736 the software, the provision of the app through an electricity supplier and the
737 adaption of business processes to account for the new tariff structures re-
738 quires the dedication of certain resources from the utility company. Among
739 these efforts, changes to the existing IT infrastructure were among the more
740 costly tasks. The execution of security tests and the training of the oper-
741 ating staff were also considerable efforts, and accounted for costs of about
742 €100,000 for the electricity supplier.

743 Adding up the costs incurred by the utility company, a total effort equal
744 to about €300,000 arose during this pilot project. While in this pilot only
745 1,000 households were served with the smart phone app, the provision of the
746 system to all 4 million households in Austria would be much less than a lin-
747 ear increase in cost. Scale effects of the provision of software are substantial
748 once a system has been carefully tested and the structures and processes
749 for its operation have been set. Hence, we expect that the provision of an
750 app like the one used for the presented field test to all Austrian households
751 would cost in the range of €1 million annually. Nevertheless, changes in
752 energy market regulation, smart metering technology, the threat landscape
753 of cyber-security, the legislation for privacy and data protection, and other
754 fields relevant for the provision of ICT tools to households, make this cost es-
755 timate subject to change. Even within the significant uncertainty associated
756 with this cost approximation, there are clearly several orders of magnitude
757 between the costs of supplying an ICT to human ecosystem and the expected
758 benefits in terms of reduced energy system costs. This seems to imply the

759 benefits greatly outweighing the costs, and emphasizes the need for further
760 research and applications of ICT systems in energy.

761 *6.2. Discussion of methodology*

762 The model validation in section 5.1 as well as the sensitivity analysis
763 in section 5.5 indicate that the developed Balmorel model is a reasonable
764 representation of the Austrian power and district heating sectors. Whilst
765 there were some relatively small deviations in the model outputs from ex-
766 pectations or historical data, these are considered to be minor in the context
767 of this analysis. The focus in this work is on analyzing relative effects of
768 assumption changes in a scenario framework, hence absolute results are sec-
769 ondary.

770 The econometric sample includes about 1,600 households in Upper Aus-
771 tria, mostly owner-occupiers with high levels of disposable income, as evi-
772 denced by the high ownership of saunas (20%). The implicit assumption in
773 this work is that this sample is representative for the whole of the Austrian
774 residential sector, which is likely not the case. The households in the sample
775 have on average 24% more residents living in the home, 39% larger living
776 areas, and 63% more often own their own properties (see Table B.1 for the
777 detailed statistics). Hence the sample under-represents lower income groups,
778 those living in rented accommodation and those with smaller dwellings and
779 fewer appliances. The flexibility potential of the under-represented groups
780 is constrained by their overall lower demand and smaller capital stock of ap-
781 pliances. The implication is therefore that the cost savings of DSF reported
782 in this paper represent an upper limit.

783 In addition, there are caveats related to the elasticities. Elasticities are
784 estimated using all of the participants in the field trial, some of whom had
785 the time-variant electricity tariffs, and some of whom do not. One third of
786 participants do not have the app (C group), so their knowledge of electricity
787 prices may be low. Households with more electricity price information and
788 feedback are expected to be more responsive to prices, which means the
789 selection of households for this analysis is highly relevant. It is reasonable
790 to expect that customers with time-variant tariffs have some knowledge of
791 the pricing schedule, as they knowingly selected these tariffs. This presents
792 a separate issue, which is self-selection of the choice of tariff; specifically,
793 households who select a time-variant tariff may have different consumption
794 patterns which make this tariff favorable to them. We argue that this is
795 unlikely to be an issue for this estimation, since it is unclear how this would
796 bias elasticity estimates within the context of the statistical models, and it

797 is unlikely that households have enough knowledge to truly optimize tariff
798 selection, as such optimization tools are not readily available to customers.

799 Furthermore, the modelling approach and scenario framework also has
800 its weaknesses. Firstly, the focus in this work is on the flexibility of de-
801 mand through active consumer participation, but there are strong synergies
802 between these measures and others in the broader context of renewable en-
803 ergy integration. Examples include, but are not limited to, energy storage,
804 supply-side flexibility, network expansion and densification, sector coupling,
805 and flexibility in other demand sectors. By focusing on the residential sec-
806 tor we intentionally analyze the system-level impacts of DSF, but neglect
807 potential flexibilities in other, large demand sectors, such as industry and
808 services. Secondly, the employed approach adopts a central planner per-
809 spective assuming complete centralized decision-making and control over
810 the energy system. In reality, of course, investment decisions for new power
811 plants involve various stakeholders with different decision criteria. More im-
812 portantly, the exploitation of widespread DSF, in this case throughout the
813 Austrian residential sector, would require an equally widespread availability
814 of technical infrastructure (e.g. smart meters, smart appliances) and market
815 frameworks. Whilst the former is at an advanced stage in Austria, the lat-
816 ter does not yet enable real time/dynamic pricing to all customers. Thirdly,
817 the employed approach does not take into account the strong current re-
818 ductions in the costs of batteries and the associated trends in households to
819 invest in stationary storage and/or electric vehicles. As these costs reduce
820 further in the future, emerging niches, such as prosumers optimizing their
821 own supply and consumption, and regional energy markets, could drastically
822 impact the energy system and invalidate such a centralized perspective like
823 the one taken in this work. Fourthly, this central planner perspective does
824 not account for the so-called ‘Lavine effect’ that consumers could poten-
825 tially have on prices when their behavior is non-marginal. The residential
826 sector as analysed here represents 28% of the total electricity demand. The
827 demand reduction for the residential sector in the REN-E-100 scenario of
828 8.5% represents just 2.4% of the total demand. So the practical impact of
829 this assumption is likely to be small.

830 There are also some limitations relating to the general methodological
831 framework employed and shown in fig. 1 above. Firstly, the employed elas-
832 ticities represent point elasticities and are not necessarily valid for large
833 price gaps. In other words, these point elasticities are assumed to be linear
834 functions, which apply throughout the whole range of analysed price and
835 demand. In reality, though, these elasticity functions would not necessarily
836 be linear, especially at the extremes of demand where a marginal change

837 is more significant than in mid-load regions. Secondly, these elasticities are
838 short term, in the sense that they were derived from a field trial that mea-
839 sured the short term behaviour of households. But they are employed herein
840 to represent how household load profiles could respond to short term price
841 changes in the short and long term. In the longer term context of decades
842 as analysed here, one would expect a larger adaptation of the demand side
843 in response to longer term changes in price patterns - for example by house-
844 holds adapting their technology portfolios. This implies that our results are
845 the lower bound of the actual behavioural change that would occur if people
846 were made more aware of dynamic electricity prices over a long period of
847 time.

848 Finally, we briefly discuss the application of the proposed method to
849 other energy systems and extensions. The general method is transferable to
850 other contexts, as long as several requirements are fulfilled. Firstly, fine-scale
851 household consumption and price data from smart meters are required. Sec-
852 ondly, the market frameworks should allow consumers to respond to price
853 signals by changing their demand profiles in the short term. Again, this
854 requires a developed ICT infrastructure in order to provide consumers with
855 real-time information, and the possibility for time-of-use tariffs. Thirdly,
856 there should be sufficient renewable energy resources in the modelled coun-
857 try to make an analysis of highly-renewable future scenarios meaningful.
858 Preferably the latter would be combined with social and political aspira-
859 tions in the country to exploit some/more of these resources. If any of these
860 requirements are not met, the method in its current form could not reliably
861 be transferred and it would instead need to be adapted to reflect these dif-
862 ferences. In terms of extensions, the coupling of energy system models with
863 empirical estimates from field test data presented herein is a novel approach
864 with plentiful opportunity for refinement and further work. For example,
865 combining the broad behavioral literature on the adoption of energy tech-
866 nologies with scenario-based system-level models would allow for quantifying
867 the effects of adoption subsidies on the cost of achieving energy transition
868 pathways, providing policymakers with a direct cost-benefit analysis.

869 **7. Summary and conclusions**

870 This paper has assessed the effects of a hypothetical full roll out of an
871 ICT to human ecosystem packaged as a smart phone app on the Austrian
872 energy system. The paper uses 15-minute resolution electricity data from
873 1,557 households participants observed over a period of 18 months. In a
874 randomized control trial framework, the participants were sorted into an

875 active (A) group, who were given the app, and a control (C) group, who
876 were not given the app. Based on this distinction, the consumption data are
877 analyzed to derive short-term own price elasticities of electricity demand for
878 both the A and C groups at the hour by month resolution (24×12 elasticity
879 estimates per group). Households within the A group who engaged with the
880 app at least once per month over the course of the field trial are labelled
881 ‘heavy users’, and were shown to have improved their energy efficiency sig-
882 nificantly. This effect is attributed to behavioral change brought about by
883 the information provided on the app. This energy efficiency treatment effect
884 of heavy app usership on electricity consumption is estimated for each hour
885 of the day across three seasons of the year (winter, summer, and transition
886 periods) using the field trial data.

887 The method extends the existing linear optimization energy system model
888 Balmorel. The price elasticities mentioned above are employed as an exoge-
889 nous input to derive changes in the exogenous electricity demand of the
890 Austrian residential sector. The analysis is carried out for the time frame
891 up to 2030 within a scenario framework of five scenarios. These include BAU
892 (business as usual) and REN (full renewable deployment) scenarios, in both
893 of which the demand is assumed to be inelastic. Three additional variants
894 of the REN scenario consider the elasticities and varied levels of the energy
895 efficiency effect, and therefore have flexible demands. By comparing these
896 five scenarios in terms of diverse economic, technical and environmental cri-
897 teria, we are able to explore the system level impact of an ICT roll out in
898 Austria. The novelty of the method lies in the coupling of DSF estimates
899 from a real-world field trial with a system model, as well as the application
900 to the Austrian energy system.

901 The findings show that DSF can lower fuel consumption and electric-
902 ity demands, promote investments in renewable technologies and lower to-
903 tal system costs in the context of building a carbon-neutral power system.
904 Overall, the results demonstrate that the impact of residential DSF on the
905 energy system is small but significant. In combination with other measures
906 to integrate renewable energy technologies, this flexibility can play a crucial
907 role. The total system cost increases by 24%, 23% and 20% in the REN-E,
908 REN-E-17 and REN-E-100 scenarios, respectively, compared to the BAU
909 scenario, due to heavy investments in renewable generation. However, the
910 reduction in cost in the REN-E scenarios compared to the REN scenario is
911 4%, 5% and 7% respectively, which is due to DSF.

912 As detailed in section 6.2, the results are subject to several methodolog-
913 ical caveats. The system-level impacts reported here should be interpreted
914 as technical upper limits of the effects from short-term demand elasticity

915 and energy efficiency improvements from an ICT system. Nevertheless, the
916 results give a clear signal that ICT-enabled DSF can be an important cost-
917 saving element that should be integrated into the future energy system and
918 considered in system-level models.

919 Acknowledgements

920 The authors gratefully acknowledge funding for this research from the
921 European Union's Horizon 2020 Research and Innovation Programme under
922 the PEAKapp project, Grant agreement #695945 ([http://www.peakapp.
923 eu/](http://www.peakapp.eu/)). The authors also gratefully acknowledge fruitful discussions with
924 Geraldine Henningsen and Jon-Gustav Kirkerud in the early stages of this
925 research. For support with the literature review and preparing figures, the
926 authors also acknowledge the support of Tabea Louisa Jaenicke, Konstantinos
927 Paidis and Matteo Carnazzola. The usual disclaimer applies.

928 References

- 929 L. Bastida, J. J. Cohen, A. Kollmann, A. Moya, J. Reichl, Exploring the
930 role of ict on household behavioural energy efficiency to mitigate global
931 warming, *Renewable and Sustainable Energy Reviews* 103 (2019) 455
932 – 462. URL: [http://www.sciencedirect.com/science/article/pii/
933 S1364032119300073](http://www.sciencedirect.com/science/article/pii/S1364032119300073). doi:[https://doi.org/10.1016/j.rser.2019.01.
934 004](https://doi.org/10.1016/j.rser.2019.01.004).
- 935 V. Azarova, D. Engel, C. Ferner, A. Kollmann, J. Reichl, Exploring the
936 impact of network tariffs on household electricity expenditures using load
937 profiles and socio-economic characteristics, *Nature Energy* 3 (2018) 317
938 – 325. doi:<https://doi.org/10.1038/s41560-018-0105-4>.
- 939 M. A. Delmas, M. Fischlein, O. I. Asensio, Information strategies and
940 energy conservation behavior: A meta-analysis of experimental studies
941 from 1975 to 2012, *Energy Policy* 61 (2013) 729 – 739. URL: [http://
942 www.sciencedirect.com/science/article/pii/S0301421513004643](http://www.sciencedirect.com/science/article/pii/S0301421513004643).
943 doi:<https://doi.org/10.1016/j.enpol.2013.05.109>.
- 944 S. Mishra, H. Koduvere, D. I. Palu, D. R. Kuhl-Thalfeldt, D. A. Rosin, As-
945 sessing Demand Side Flexibility with Renewable Energy Resources, 2016
946 IEEE 16th International Conference on Environment and Electrical En-
947 gineering (EEEIC) (2016). URL: <https://www.ieee-pes.org>.

- 948 F. M. Andersen, S. G. Jensen, H. V. Larsen, P. Meibom, H. Ravn, K. Skytte,
949 M. Togeby, Analyses of Demand Response in Denmark, Technical Report,
950 Risø National Laboratory, 2006. URL: [https://www.ea-energianalyse.
951 dk/reports/511_Analyses_of_Demand_Response_in_Denmark.pdf](https://www.ea-energianalyse.dk/reports/511_Analyses_of_Demand_Response_in_Denmark.pdf).
- 952 W. Matar, A look at the response of households to time-of-use electricity
953 pricing in Saudi Arabia and its impact on the wider economy, Energy
954 Strategy Reviews 16 (2017) 13–23. URL: [https://doi.org/10.1016/j.
955 esr.2017.02.002](https://doi.org/10.1016/j.esr.2017.02.002). doi:10.1016/j.esr.2017.02.002.
- 956 M. Ali, A. Alahäivälä, F. Malik, M. Humayun, A. Safdarian, M. Lehtonen, A
957 market-oriented hierarchical framework for residential demand response,
958 International Journal of Electrical Power and Energy Systems 69 (2015)
959 257–263. URL: [http://dx.doi.org/10.1016/j.
960 ijepes.2015.01.020](http://dx.doi.org/10.1016/j.ijepes.2015.01.020). doi:10.1016/j.ijepes.2015.01.020.
- 961 P. H. Li, S. Pye, Assessing the benefits of demand-side flexibility in residen-
962 tial and transport sectors from an integrated energy systems perspective,
963 Applied Energy 228 (2018) 965–979. URL: [https://doi.org/10.1016/
964 j.apenergy.2018.06.153](https://doi.org/10.1016/j.apenergy.2018.06.153). doi:10.1016/j.apenergy.2018.06.153.
- 965 P. E. Grohnheit, G. Klavs, Elastic electricity and heat demand in the
966 Balmorel model, Second International Conference: Simulation, Gaming,
967 Training and Business Process Reengineering in Operations”, Riga (2000).
968 URL: <http://www.itl.rtu.lv/RigaConf2000/>.
- 969 s. G. Tveten, T. F. Bolkesjø, I. Ilieva, Increased demand-side flexibility:
970 market effects and impacts on variable renewable energy integration., In-
971 ternational Journal of Sustainable Energy Planning and Management 11
972 (2016) 33—50. doi:<https://doi.org/10.5278/ijsepm.2016.11.4>.
- 973 J. Katz, F. M. Andersen, P. E. Morthorst, Load-shift incentives for house-
974 hold demand response: Evaluation of hourly dynamic pricing and rebate
975 schemes in a wind-based electricity system, Energy 115 (2016) 1602–1616.
976 doi:10.1016/j.energy.2016.07.084.
- 977 H. Marañón-Ledesma, A. Tomasgard, Analyzing demand response in a dy-
978 namic capacity expansion model for the european power market, En-
979 ergies 12 (2019). URL: <https://www.mdpi.com/1996-1073/12/15/2976>.
980 doi:10.3390/en12152976.
- 981 H. C. Gils, Economic potential for future demand response in Germany -
982 Modeling approach and case study, Applied Energy 162 (2016) 401–415.

- 983 URL: <http://dx.doi.org/10.1016/j.apenergy.2015.10.083>. doi:10.
984 [1016/j.apenergy.2015.10.083](https://doi.org/10.1016/j.apenergy.2015.10.083).
- 985 E. Panos, T. Kober, A. Wokaun, Long term evaluation of electric storage
986 technologies vs alternative flexibility options for the Swiss energy system,
987 Applied Energy 252 (2019) 113470. URL: <https://doi.org/10.1016/j.apenergy.2019.113470>.
988 doi:10.1016/j.apenergy.2019.113470.
- 989 M. Child, A. Nordling, C. Breyer, Scenarios for a sustainable energy system
990 in the Åland Islands in 2030, Energy Conversion and Management 137
991 (2017) 49–60. URL: [http://dx.doi.org/10.1016/j.enconman.2017.](http://dx.doi.org/10.1016/j.enconman.2017.01.039)
992 [01.039](https://doi.org/10.1016/j.enconman.2017.01.039). doi:10.1016/j.enconman.2017.01.039.
- 993 S. Pilpola, V. Arabzadeh, J. Mikkola, P. D. Lund, Analyzing national and
994 local pathways to carbon-neutrality from technology, emissions, and re-
995 siliance perspectives—Case of Finland, Energies 12 (2019). doi:10.3390/
996 [en12050949](https://doi.org/10.3390/en12050949).
- 997 J. Sijm, P. Koutstaal, Ö. Özdemir, M. van Hout, Energy transition impli-
998 cations for demand and supply of power system flexibility: A case study
999 of the Netherlands within an EU electricity market and trading context,
1000 2019. doi:10.1007/978-3-030-03374-3_21.
- 1001 P. D. Lund, K. Skytte, S. Bolwig, T. F. Bolkesjö, C. Bergaentzlé, P. A.
1002 Gunkel, J. G. Kirkerud, A. Klitkou, H. Koduvere, A. Gravelins, D. Blum-
1003 berga, L. Söder, Pathway analysis of a zero-emission transition in the
1004 Nordic-Baltic region, Energies 12 (2019) 1–20. doi:10.3390/en12173337.
- 1005 J. Anjo, D. Neves, C. Silva, A. Shivakumar, M. Howells, Modeling the long-
1006 term impact of demand response in energy planning: The Portuguese
1007 electric system case study, Energy 165 (2018) 456–468. doi:10.1016/j.
1008 [energy.2018.09.091](https://doi.org/10.1016/j.energy.2018.09.091).
- 1009 S. G. Jensen, M. Togeby, M. Hindsberger, T. E. Pedersen, Valuation of De-
1010 mand Response in the Nordic Power Market, Paper presented at Demand
1011 Response in Australia - Delivering on the Potential, 16 November 2006,
1012 Melbourne, Australia (2006). URL: <http://www.ieadsm.org>.
- 1013 A. Alhamwi, W. Medjroubi, T. Vogt, C. Agert, GIS-based urban energy
1014 systems models and tools: Introducing a model for the optimisation of
1015 flexibilisation technologies in urban areas, Applied Energy 191 (2017) 1–9.
1016 URL: <http://dx.doi.org/10.1016/j.apenergy.2017.01.048>. doi:10.
1017 [1016/j.apenergy.2017.01.048](https://doi.org/10.1016/j.apenergy.2017.01.048).

- 1018 S. Bolwig, G. Bazbauers, A. Klitkou, P. D. Lund, A. Blumberga, A. Grav-
1019 elsins, D. Blumberga, Review of modelling energy transitions pathways
1020 with application to energy system flexibility, *Renewable and Sustainable*
1021 *Energy Reviews* 101 (2018) 440–452. URL: [https://doi.org/10.1016/](https://doi.org/10.1016/j.rser.2018.11.019)
1022 [j.rser.2018.11.019](https://doi.org/10.1016/j.rser.2018.11.019). doi:10.1016/j.rser.2018.11.019.
- 1023 F. Wiese, R. Bramstoft, H. Koduvere, A. P. Alonso, O. Balyk, J. G.
1024 Kirkerud, Åsa Grytli Tveten, T. F. Bolkesjø, M. Münster, H. Ravn,
1025 Balmorel open source energy system model, *Energy Strategy Re-*
1026 *views* 20 (2018) 26 – 34. URL: [http://www.sciencedirect.com/](http://www.sciencedirect.com/science/article/pii/S2211467X18300038)
1027 [science/article/pii/S2211467X18300038](http://www.sciencedirect.com/science/article/pii/S2211467X18300038). doi:[https://doi.org/10.](https://doi.org/10.1016/j.esr.2018.01.003)
1028 [1016/j.esr.2018.01.003](https://doi.org/10.1016/j.esr.2018.01.003).
- 1029 J. Sijm, P. Gockel, J. de Joode, W. van Westering, M. Musterd, The demand
1030 for flexibility of the power system in the Netherlands, 2015-2050. Report
1031 of phase 1 of the FLEXNET project, Petten: ECN, 2017. URL: [https:](https://publications.ecn.nl/ECN-E--17-037)
1032 [//publications.ecn.nl/ECN-E--17-037](https://publications.ecn.nl/ECN-E--17-037).
- 1033 R. Loulou, M. Labriet, Etsap-tiam: the times integrated assessment
1034 model part i: Model structure, *Computational Management Science*
1035 5 (2008) 7–40. URL: <https://doi.org/10.1007/s10287-007-0046-z>.
1036 doi:10.1007/s10287-007-0046-z.
- 1037 King Abdullah Petroleum Studies and Research Center (“KAPSARC”),
1038 Kapsarc energy model (kem), 2020. URL: [https://www.kapsarc.org/](https://www.kapsarc.org/research/projects/kapsarc-energy-model-kem/)
1039 [research/projects/kapsarc-energy-model-kem/](https://www.kapsarc.org/research/projects/kapsarc-energy-model-kem/), [Online; accessed
1040 2020-01-22].
- 1041 Y. Scholz, H. C. Gils, R. C. Pietzcker, Application of a high-detail energy
1042 system model to derive power sector characteristics at high wind and
1043 solar shares, *Energy Economics* 64 (2017) 568 – 582. URL: [http://](http://www.sciencedirect.com/science/article/pii/S0140988316301682)
1044 www.sciencedirect.com/science/article/pii/S0140988316301682.
1045 doi:<https://doi.org/10.1016/j.eneco.2016.06.021>.
- 1046 M. Howells, H. Rogner, N. Strachan, C. Heaps, H. Huntington,
1047 S. Kypreos, A. Hughes, S. Silveira, J. DeCarolis, M. Bazillian,
1048 A. Roehrl, Osemosys: The open source energy modeling system: An
1049 introduction to its ethos, structure and development, *Energy Pol-*
1050 *icy* 39 (2011) 5850 – 5870. URL: [http://www.sciencedirect.com/](http://www.sciencedirect.com/science/article/pii/S0301421511004897)
1051 [science/article/pii/S0301421511004897](http://www.sciencedirect.com/science/article/pii/S0301421511004897). doi:[https://doi.org/10.](https://doi.org/10.1016/j.enpol.2011.06.033)
1052 [1016/j.enpol.2011.06.033](https://doi.org/10.1016/j.enpol.2011.06.033), sustainability of biofuels.

- 1053 Department of Development and Planning, Aalborg University, Energyplan:
1054 Advanced energy system analysis computer model, 2020. URL: <https://www.energyplan.eu/>, [Online; accessed 2020-01-22].
1055
- 1056 A. Alhamwi, W. Medjroubi, T. Vogt, C. Agert, Flexigis: an open source
1057 gis-based platform for the optimisation of flexibility options in urban
1058 energy systems, *Energy Procedia* 152 (2018) 941 – 946. URL: <http://www.sciencedirect.com/science/article/pii/S1876610218306416>.
1059 doi:<https://doi.org/10.1016/j.egypro.2018.09.097>, cleaner Energy
1060 for Cleaner Cities.
1061
- 1062 J. Reichl, J. Cohen, V. Azarova, A. Kollman, N. Moller, G. Henningsen,
1063 S. Raino, M. Esteras, Deliverable 4.1: Report on the quantitative field
1064 experiment analysis, Technical Report, PEAKapp Project, 2019. URL:
1065 <http://www.peakapp.eu/wp-content/uploads/2019/07/D4.1.pdf>.
- 1066 X. Zhu, L. Li, K. Zhou, X. Zhang, S. Yang, A meta-analysis
1067 on the price elasticity and income elasticity of residential elec-
1068 tricity demand, *Journal of Cleaner Production* 201 (2018) 169
1069 – 177. URL: <http://www.sciencedirect.com/science/article/pii/S0959652618323588>. doi:<https://doi.org/10.1016/j.jclepro.2018.08.027>.
1070
1071
- 1072 K. Jessoe, D. Rapson, Knowledge is (less) power: Experimental evidence
1073 from residential energy use, *American Economic Review* 104 (2014) 1417–
1074 38. URL: <http://www.aeaweb.org/articles?id=10.1257/aer.104.4.1417>. doi:[10.1257/aer.104.4.1417](https://doi.org/10.1257/aer.104.4.1417).
1075
- 1076 S. Martin, N. Rivers, Information provision, market incentives,
1077 and household electricity consumption: Evidence from a large-
1078 scale field deployment, *Journal of the Association of Environ-
1079 mental and Resource Economists* 5 (2018) 207–231. URL:
1080 <https://www.journals.uchicago.edu/doi/10.1086/694036>.
1081 doi:[10.1086/694036](https://doi.org/10.1086/694036). arXiv:<https://doi.org/10.1086/694036>.
- 1082 B. Gilbert, J. G. Zivin, Dynamic salience with intermittent billing: Evidence
1083 from smart electricity meters, *Journal of Economic Behavior & Orga-
1084 nization* 107 (2014) 176 – 190. URL: <http://www.sciencedirect.com/science/article/pii/S016726811400081X>. doi:<https://doi.org/10.1016/j.jebo.2014.03.011>.
1085
1086
- 1087 R. McKenna, L. Hofmann, E. Merkel, W. Fichtner, N. Strachan, Analysing
1088 socioeconomic diversity and scaling effects on residential electricity

- 1089 load profiles in the context of low carbon technology uptake, *En-*
1090 *ergy Policy* 97 (2016) 13 – 26. URL: [http://www.sciencedirect.com/](http://www.sciencedirect.com/science/article/pii/S0301421516303469)
1091 [science/article/pii/S0301421516303469](http://www.sciencedirect.com/science/article/pii/S0301421516303469). doi:[https://doi.org/10.](https://doi.org/10.1016/j.enpol.2016.06.042)
1092 [1016/j.enpol.2016.06.042](https://doi.org/10.1016/j.enpol.2016.06.042).
- 1093 K. Buchanan, R. Russo, B. Anderson, The question of en-
1094 ergy reduction: The problem(s) with feedback, *Energy Pol-*
1095 *icy* 77 (2015) 89 – 96. URL: [http://www.sciencedirect.com/](http://www.sciencedirect.com/science/article/pii/S0301421514006739)
1096 [science/article/pii/S0301421514006739](http://www.sciencedirect.com/science/article/pii/S0301421514006739). doi:[https://doi.org/10.](https://doi.org/10.1016/j.enpol.2014.12.008)
1097 [1016/j.enpol.2014.12.008](https://doi.org/10.1016/j.enpol.2014.12.008).
- 1098 J. Schleich, M. Klobasa, S. Gözl, M. Brunner, Effects of feedback on resi-
1099 dential electricity demand—findings from a field trial in Austria, *Energy*
1100 *Policy* 61 (2013) 1097 – 1106. URL: [http://www.sciencedirect.com/](http://www.sciencedirect.com/science/article/pii/S0301421513003443)
1101 [science/article/pii/S0301421513003443](http://www.sciencedirect.com/science/article/pii/S0301421513003443). doi:[https://doi.org/10.](https://doi.org/10.1016/j.enpol.2013.05.012)
1102 [1016/j.enpol.2013.05.012](https://doi.org/10.1016/j.enpol.2013.05.012).
- 1103 J. Schleich, C. Faure, M. Klobasa, Persistence of the ef-
1104 fects of providing feedback alongside smart metering devices on
1105 household electricity demand, *Energy Policy* 107 (2017) 225–
1106 233. URL: [http://www.sciencedirect.com/science/article/pii/](http://www.sciencedirect.com/science/article/pii/S0301421517302793)
1107 [S0301421517302793](http://www.sciencedirect.com/science/article/pii/S0301421517302793). doi:[10.1016/j.enpol.2017.05.002](https://doi.org/10.1016/j.enpol.2017.05.002).
- 1108 H. Ravn, The Balmorel Model Structure 03 (2001) 132. URL: [http:](http://balmorel.com/images/downloads/model/BMS303-20190311.pdf)
1109 [//balmorel.com/images/downloads/model/BMS303-20190311.pdf](http://balmorel.com/images/downloads/model/BMS303-20190311.pdf).
1110 doi:[10.5281/zenodo.823692](https://doi.org/10.5281/zenodo.823692).
- 1111 H.-K. Ringkjøb, P. M. Haugan, I. M. Solbrekke, A review of modelling
1112 tools for energy and electricity systems with large shares of variable re-
1113 newables, *Renewable and Sustainable Energy Reviews* 96 (2018) 440
1114 – 459. URL: [http://www.sciencedirect.com/science/article/pii/](http://www.sciencedirect.com/science/article/pii/S1364032118305690)
1115 [S1364032118305690](http://www.sciencedirect.com/science/article/pii/S1364032118305690). doi:[https://doi.org/10.1016/j.rser.2018.08.](https://doi.org/10.1016/j.rser.2018.08.002)
1116 [002](https://doi.org/10.1016/j.rser.2018.08.002).
- 1117 D. Keles, P. Jochem, R. McKenna, M. Ruppert, W. Fichtner, Meeting
1118 the modeling needs of future energy systems, *Energy Technol-*
1119 *ogy* 5 (2017) 1007–1025. URL: [https://onlinelibrary.wiley.](https://onlinelibrary.wiley.com/doi/abs/10.1002/ente.201600607)
1120 [com/doi/abs/10.1002/ente.201600607](https://onlinelibrary.wiley.com/doi/abs/10.1002/ente.201600607). doi:[10.1002/ente.201600607](https://doi.org/10.1002/ente.201600607).
1121 [arXiv:https://onlinelibrary.wiley.com/doi/pdf/10.1002/ente.201600607](https://onlinelibrary.wiley.com/doi/pdf/10.1002/ente.201600607).
- 1122 J. DeCarolis, H. Daly, P. Dodds, I. Keppo, F. Li, W. Mc-
1123 Dowall, S. Pye, N. Strachan, E. Trutnevyte, W. Usher, M. Win-

- 1124 ning, S. Yeh, M. Zeyringer, Formalizing best practice for en-
1125 ergy system optimization modelling, Applied Energy 194 (2017)
1126 184 – 198. URL: [http://www.sciencedirect.com/science/article/
1127 pii/S0306261917302192](http://www.sciencedirect.com/science/article/pii/S0306261917302192). doi:[https://doi.org/10.1016/j.apenergy.
1128 2017.03.001](https://doi.org/10.1016/j.apenergy.2017.03.001).
- 1129 E-Control, E-Control Database, 2019. URL: [https://www.e-control.at/
1130 documents/](https://www.e-control.at/documents/), [Online; accessed 2020-01-24].
- 1131 P.-H. Li, S. Pye, Assessing the benefits of demand-side flexibility in residen-
1132 tial and transport sectors from an integrated energy systems perspective.
1133 Applied Energy 228 (2018) 965—979. doi:[https://doi.org/10.1016/
1134 j.apenergy.2018.06.153](https://doi.org/10.1016/j.apenergy.2018.06.153).
- 1135 J. G. Kirkerud, N. O. Nagel, T. F. Bolkesjo, The Role of Demand Response
1136 in the Future Renewable Northern European Energy System. Unpublished
1137 (2019).
- 1138 International Energy Agency, Technology Roadmap (2010) 48.
1139 URL: [https://www.pvaustria.at/wp-content/uploads/2013/07/
1140 Roadmap-IEA.pdf](https://www.pvaustria.at/wp-content/uploads/2013/07/Roadmap-IEA.pdf), [Online; accessed 2020-01-24].
- 1141 Energiewerkstatt, RSA - Studio iSPACE, Meteotest, Wegener Center, Win-
1142 datlas, 2014.
- 1143 Austrian Power Grid AG, Austrian Power Grid, 2020. URL: [https://www.
1144 apg.at/en/markt/balancing](https://www.apg.at/en/markt/balancing), [Online; accessed 2020-01-24].
- 1145 ENTSO-E (European Network of Transmission System Operators - Elec-
1146 tricity), Transparency Platform Database, 2020. URL: [https://www.
1147 entsoe.eu/data/transparency-platform/](https://www.entsoe.eu/data/transparency-platform/), [Online; accessed 2020-01-
1148 24].
- 1149 APCS Power Clearing and Settlement AG, Synthetische Lastprofile, 2020.
1150 URL: [https://www.apcs.at/de/clearing/technisches-clearing/
1151 lastprofile](https://www.apcs.at/de/clearing/technisches-clearing/lastprofile), [Online; accessed 2020-01-24].
- 1152 International Energy Agency, Nordic Energy Research,
1153 NETP2016-Nordic Energy Technology Perspectives,
1154 2016. URL: [https://www.nordicenergy.org/project/
1155 nordic-energy-technology-perspectives/](https://www.nordicenergy.org/project/nordic-energy-technology-perspectives/), [Online; accessed 2020-
1156 01-24].

- 1157 European Environment Information and Observation Network (Eionet),
1158 Eionet Portal, 2020. URL: <https://www.eionet.europa.eu>, [Online; ac-
1159 cessed 2020-01-24].
- 1160 Austrian Power Grid AG, Austrian Power Grid and Transmis-
1161 sion, 2020. URL: [https://www.apg.at/en/markt/Markttransparenz/
1162 Uebertragung/NTC-Prognosen](https://www.apg.at/en/markt/Markttransparenz/Ubertragung/NTC-Prognosen), [Online; accessed 2020-01-24].
- 1163 D. Suna, H. Aghaie, Austrian Institute of Technology. Unpublished, , 2019.
1164 [Personal correspondence].
- 1165 R. Halvorsen, R. Palmquist, The interpretation of dummy variables
1166 in semilogarithmic equations, American Economic Review 70 (1980)
1167 474–75. URL: [https://EconPapers.repec.org/RePEc:aea:aecrev:v:
1168 70:y:1980:i:3:p:474-75](https://EconPapers.repec.org/RePEc:aea:aecrev:v:70:y:1980:i:3:p:474-75).

1169 Appendix A. Employed data and assumptions

1170 In this paper, Austria was modelled alone as a country which contains
1171 one region and two areas (the one with District Heating called AT_DH and
1172 one without it called AT_A_NoDH). Interconnectors were added as net ex-
1173 change capacities with neighbouring countries: Germany, Italy, Hungary,
1174 Switzerland, Czech Republic and Slovenia. The available time slices in Bal-
1175 morel are years, seasons (as weeks) and terms (as hours). The set for weeks
1176 is from S01 to S52 weeks and for hours is from T1 to T168 hours. In order
1177 to obtain a high level of precision in the dispatch optimization, the hourly
1178 time resolution was adopted for the full year.

1179

1180 The input data consists among others of energy demand, wind and so-
1181 lar profiles, wind, solar PV and solar heating full load hours, existing and
1182 future transmission capacities and generation plants, technical restrictions,
1183 technology costs, technology efficiency's and their lifetime, fuel prices, CO₂
1184 taxes.

1185

1186 The employed data is based on multiple sources at the national level: E-
1187 control, ENTSO-E, APG, AIT, NETP, Technology Roadmap ([International
1188 Energy Agency, 2010](#)) and Windatlas & Windpotentialstudie Österreich
1189 ([Energiewerkstatt, RSA - Studio iSPACE, Meteotest, Wegener Center, 2014](#)).
1190 Below, the main sources used for the most relevant data of the model are
1191 stated.

1192

- 1193 • CO₂ prices:

1194 The emission policy data used in the model was from [E-Control \(2019\)](#).
1195 In fig. [A.1](#) the CO₂ price development throughout the modelled time
1196 horizon is illustrated.

- 1197 • System capacity:

1198 The system capacity power data was taken from [Austrian Power Grid
1199 AG \(2020\)](#) i.e. Austrian Power Grid. The employed data assumed
1200 decommissioning of 100% of the technologies capacities when their
1201 economic lifetime comes to the end. Within the scenario framework
1202 defined below, endogenous and exogenous investments in new capacity
1203 are possible.

- 1204 • Energy demand:

1205 The source used for the energy demand data was [ENTSO-E \(European](#)

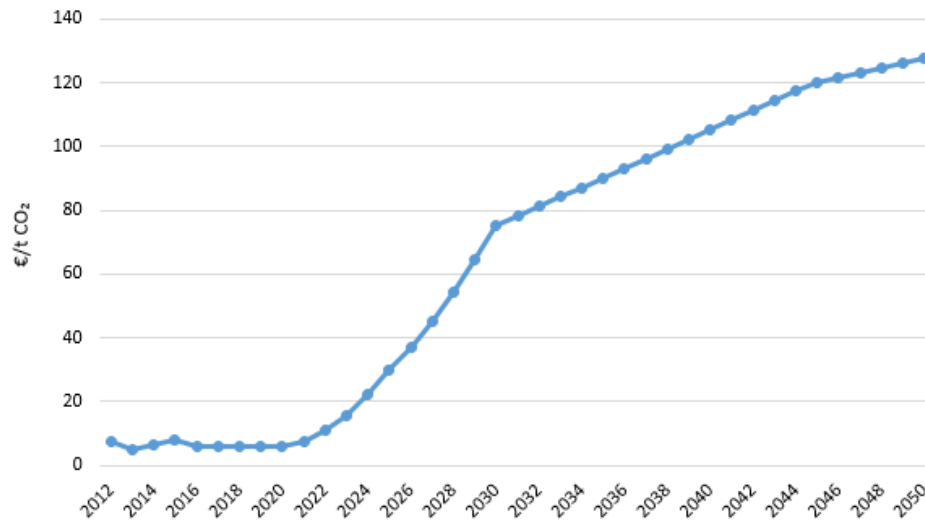

Figure A.1: Assumed CO₂ price development in all scenarios based on E-Control (2019)

1206 [Network of Transmission System Operators - Electricity](#) (2020), the
 1207 European Network of Transmission System Operators for Electricity.
 1208 Load profiles were taken from [APCS Power Clearing and Settlement](#)
 1209 [AG](#) (2020).

- 1210 • Fuel prices:
 1211 Fuel prices were obtained from NETP 2016 ([International Energy Agency, Nordic Energy Research, 2016](#)), which was launched by the
 1212 International Energy Agency and Nordic Energy Research. However,
 1213 fuel data was collected from the [European Environment Information and Observation Network \(Eionet\)](#) (2020).
 1214
 1215
 1216

1217 Figure [A.2](#) depicts the fuel fossil fuel price development for BAU (or-
 1218 ange) and REN (blue). Obviously, the developments are very different
 1219 from 2030 onwards. The fossil fuels in the Austrian energy system
 1220 consist of coal (coal and lignite), oil (heavy fuel oil and fuel oil) and
 1221 natural gas. In the BAU scenario fossil fuel prices stay at a relatively
 1222 constant level. The prices in the REN scenario follow the same trend
 1223 for the first 10 years (2020 to 2030) but then jump to an artificial price
 1224 of 100€ per gigajoule and then all increase at the same annual rate of
 1225 approximately 7%. The detailed prices and growth rates are presented
 1226 in table [A.1](#) for BAU and table [A.2](#) for REN.

Table A.1: Fuel price development in BAU scenario based on [International Energy Agency, Nordic Energy Research \(2016\)](#)

	unit	natural gas	coal	lignite	fuel oil	heavy fuel oil	light oil
2020	€/GJ	5.64	2.31	0.75	5.43	12.60	9.93
aver. annual rate	%	5	2	3	9	0	6
2029	€/GJ	8.19	2.65	0.99	11.43	12.60	15.94
2030	€/GJ	8.32	2.67	1.01	12.10	12.60	16.61
aver. annual rate	%	1	0.2	0.1	0.1	0	0.1
2050	€/GJ	10.26	2.81	0.96	11.54	12.60	16.05

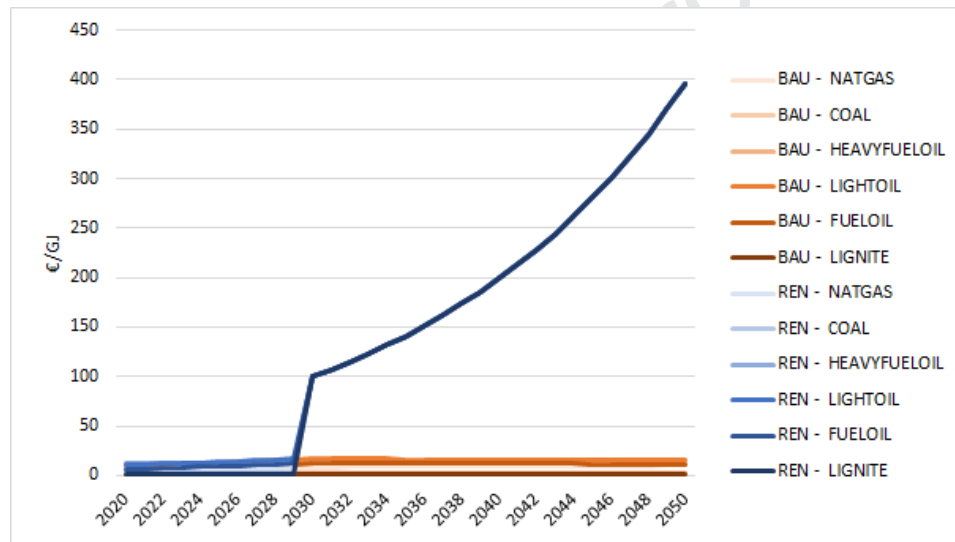
Figure A.2: Fuel price development in BAU and REN scenarios based on [International Energy Agency, Nordic Energy Research \(2016\)](#) & own assumptions for RENTable A.2: Fuel price development in REN scenario based on [International Energy Agency, Nordic Energy Research \(2016\)](#) & own assumptions

	unit	natural gas	coal	lignite	fuel oil	heavy fuel oil	light oil
2020	€/GJ	5.92	2.43	0.79	5.70	13.23	10.43
aver. annual rate	%	5	2	3	9	0	6
2029	€/GJ	8.60	2.79	1.04	12.00	13.23	16.74
2030	€/GJ	100	100	100	100	100	100
aver. annual rate	%	7	7	7	7	7	7
2050	€/GJ	396.07	396.07	396.07	396.07	396.07	396.07

- 1227 • Interconnectors:
1228 [Austrian Power Grid AG \(2020\)](#) and [ENTSO-E \(European Network of](#)
1229 [Transmission System Operators - Electricity\) \(2020\)](#) were the sources
1230 used for the interconnectors, representing the net transfer capacities
1231 between countries.
- 1232 • Technology data:
1233 [Suna and Aghaie \(2019\)](#) from the Austrian Institute of Technology
1234 (AIT) provided technology data, which was collected in collaboration
1235 with the EEG group at the TU-Wien and from the Austrian private
1236 sector.

1237 **Appendix B. Statistical indicators**

variable	units	AT _{all} *	PEAKapp sample	difference [%]
number of households (hhs)	[-]	3890000	1571	-99.96
number of residents	[mean/hh]	2.22	2.76	+24.32
area	[m ² /hh]	99.6	138.1	+38.66
home owned	[%/hh]	0.48	0.78	+63.18
dryer	[%/hh]	0.33	0.589	+78.48
swimming pool	[%/hh]	not specified	0.264	-
sauna	[%/hh]	not specified	0.205	-

Table B.1: Comparison of selected statistical indicators between the entire Austrian residential sector and the PEAKapp participants. *Based on: https://www.statistik.at/web_de/statistiken/menschen_und_gesellschaft/wohnen/index.html

1238 Appendix C. Econometric estimations

Table C.1: Estimated energy efficiency effects of 'heavy' app usage by hour and season

	Transition times Spring and Fall effects		Summer time effects		Winter time effects	
	Treatment eff.	Coeff. Est.	Treatment eff.	Coeff. Est.	Treatment eff.	Coeff. Est.
Average	Specification:					
Avg. Effects	-6.26%***	-0.065	-6.86%***	-0.071	-6.8%	-0.007
Hourly	Specification:					
Midnight - 1am	-1.13%	-0.011	.39%	0.004	3.71%	0.036
1 - 2am	-1.12%	0.011	.15%	-0.001	4.04%	-0.041
2 - 3am	.65%	-0.006	.15%	-0.001	5.77%	-0.059
3 - 4am	1.75%	-0.018	1.08%	-0.011	6.22%	-0.064
4 - 5am	-.3%	0.003	-2.34%	0.023	5.38%	-0.055
5 - 6am	-1.%	0.010	-4.99%	0.049	5.11%	-0.052
6 - 7am	-3.58%	0.035	-11.32%***	0.107	2.22%	-0.022
7 - 8am	-11.5%***	0.109	-17.33%***	0.160	-2.27%	0.022
8 - 9am	-14.65%***	0.137	-12.69%***	0.120	-4.33%	0.042
9 - 10am	-13.64%***	0.128	-11.81%***	0.112	-6.75%	0.065
10 - 11am	-11.71%***	0.111	-10.56%***	0.100	-5.79%	0.056
11am - 12pm	-10.96%***	0.104	-8.93%**	0.086	-5.73%	0.056
12 - 1pm	-13.2%***	0.124	-10.85%***	0.103	-8.88%**	0.085
1 - 2pm	-12.76%***	0.120	-11.38%***	0.108	-9.28%**	0.089
2 - 3pm	-12.27%***	0.116	-10.87%**	0.103	-6.7%	0.065
3 - 4pm	-12.75%***	0.120	-12.86%***	0.121	-5.2%	0.051
4 - 5pm	-13.3%***	0.125	-13.15%***	0.124	-3.82%	0.037
5 - 6pm	-12.86%***	0.121	-15.34%***	0.143	-2.04%	0.020
6 - 7pm	-9.37%***	0.090	-12.69%***	0.119	-2.47%	0.024
7 - 8pm	-5.25%**	0.051	-9.55%**	0.091	.08%	-0.001
8 - 9pm	-3.18%	0.031	-3.42%	0.034	.55%	-0.006
9 - 10pm	-3.19%	0.031	-4.07%	0.040	3.26%	-0.033
10 - 11pm	-1.99%	0.020	-1.7%	0.017	2.8%	-0.028
11pm - Midnight	-2.15%	0.021	-2.62%	0.026	3.72%	-0.038

The table gives β_0 estimates from regressions of models in eq. (2); $N = 65,092,913$ and adj. $R^2 = 0.45$ in both the Average and Hourly Specifications; * significant at $\alpha = 10\%$, ** significant at $\alpha = 5\%$, *** significant at $\alpha = 1\%$

Treatment effects are calculated from coefficient estimates following Halvorsen and Palmquist (1980), as we have a log dep. var. and dummy variable regressor.

Table C.2: Estimated own-price elasticities of electricity demand by hour and month

	Experimental Group	Full Year Elasticities	Jan. Elasticities	Feb. Elasticities	March Elasticities	April Elasticities	May Elasticities	June Elasticities	July Elasticities	Aug. Elasticities	Sept. Elasticities	Oct. Elasticities	Nov. Elasticities	Dec. Elasticities
Average Specification	C	-0.115	-0.0110	-0.0250	-0.0712	-0.00795	-0.191	-0.227*	-0.194	-0.214*	-0.123	-0.136	-0.123	-0.0222
	A	-0.184**	-0.183**	-0.2020**	-0.168	-0.207**	-0.188**	-0.167*	-0.195**	-0.162*	-0.143	-0.172*	-0.279***	-0.154*
Hourly Specification:														
Midnight - 1am														
	C	-0.0425	-0.0190	-0.0379	-0.0807	-0.000313	-0.0468	-0.0835	-0.0196	-0.0646	0.00605	-0.110	-0.135	-0.0195
	A	-0.0919	-0.103	-0.131	-0.0796	-0.121	-0.0715	-0.0654	-0.0649	-0.0663	-0.0571	-0.110	-0.198*	-0.0942
1 - 2am	C	-0.0240	0.0193	-0.0612	-0.0661	0.0131	-0.0211	-0.0467	0.00588	-0.0601	0.00719	-0.0674	-0.0662	0.0112
	A	-0.0716	-0.0658	-0.153	-0.0597	-0.109	-0.0490	-0.0237	-0.0325	-0.0598	-0.0511	-0.0681	-0.127	-0.0630
2 - 3am	C	-0.0356	0.0165	-0.0587	-0.0755	0.0418	-0.0236	-0.0640	-0.0270	-0.112	-0.0165	-0.0976	-0.0962	-0.00162
	A	-0.0834	-0.0676	-0.155	-0.0739	-0.0831	-0.0441	-0.0357	-0.0626	-0.112	-0.0804	-0.0977	-0.161	-0.0763
3 - 4am	C	-0.0411	-0.0120	-0.0829	-0.0973	0.0349	-0.0497	-0.0382	-0.00475	-0.0821	0.00678	-0.0970	-0.152	-0.0164
	A	-0.0913	-0.103	-0.175	-0.0934	-0.0938	-0.0713	-0.0129	-0.0401	-0.0912	-0.0631	-0.0992	-0.217*	-0.0917
4 - 5am	C	-0.0137	-0.00591	-0.0483	-0.0975	0.0369	0.0491	0.00482	0.00106	-0.0221	0.0412	-0.0441	-0.121	-0.0225
	A	-0.0593	-0.0868	-0.137	-0.0912	-0.0841	0.0328	0.0384	-0.0387	-0.0314	-0.0280	-0.0442	-0.174	-0.0882
5 - 6am	C	0.0198	0.0746	0.00996	-0.0762	0.0783	0.0211	-0.0534	0.0261	-0.0334	0.102	0.0188	0.0524	0.0778
	A	-0.0317	-0.0131	-0.0844	-0.0725	-0.0487	-0.00408	-0.0240	-0.0187	-0.0546	0.0335	-0.00692	-0.00581	0.00613
6 - 7am	C	-0.0577	0.0820	0.0473	-0.0191	-0.00267	-0.199	-0.189	-0.122	-0.129	-0.00641	-0.00541	-0.0482	0.0162
	A	-0.105	0.00497	-0.0433	-0.0183	-0.128	-0.211*	-0.157	-0.162	-0.150	-0.0756	-0.0164	-0.0944	-0.0491
7 - 8am	C	-0.143	0.00134	-0.0688	-0.171	-0.154	-0.250*	-0.213	-0.189	-0.166	-0.0929	-0.0765	-0.201	-0.0405
	A	-0.197**	-0.0846	-0.157	-0.168	-0.273**	-0.275***	-0.187*	-0.239**	-0.194*	-0.168	-0.108	-0.267**	-0.108
8 - 9am	C	-0.231*	-0.265*	-0.310*	-0.352**	-0.156	-0.291**	-0.231*	-0.233	-0.225	-0.159	-0.319*	-0.479***	-0.241*
	A	-0.271***	-0.346***	-0.391***	-0.338***	-0.268***	-0.300***	-0.189*	-0.260***	-0.236**	-0.219**	-0.331***	-0.525***	-0.301***
9 - 10am	C	-0.430***	-0.394***	-0.344***	-0.424***	-0.324***	-0.518***	-0.483***	-0.464***	-0.412***	-0.347**	-0.396**	-0.545***	-0.367***
	A	-0.466***	-0.469***	-0.409***	-0.403***	-0.430***	-0.531***	-0.443***	-0.487***	-0.419***	-0.407***	-0.396***	-0.578***	-0.423***
10 - 11am	C	-0.374***	-0.314**	-0.255	-0.297*	-0.229	-0.525***	-0.482***	-0.452***	-0.438***	-0.369**	-0.440***	-0.331**	
	A	-0.419***	-0.385***	-0.332***	-0.280**	-0.346***	-0.552***	-0.452***	-0.491***	-0.451***	-0.446***	-0.374***	-0.481***	-0.392***
11am - 12pm	C	-0.397***	-0.321**	-0.315*	-0.320*	-0.270*	-0.527***	-0.464***	-0.515***	-0.445***	-0.423**	-0.428**	-0.487***	-0.330**
	A	-0.443***	-0.386***	-0.373***	-0.290*	-0.379***	-0.559***	-0.455***	-0.567***	-0.472***	-0.505***	-0.430***	-0.525***	-0.385***
12 - 1pm	C	-0.439***	-0.391**	-0.343**	-0.371**	-0.212	-0.560***	-0.563***	-0.567***	-0.552***	-0.443***	-0.421**	-0.521***	-0.381***
	A	-0.481***	-0.444***	-0.401***	-0.346**	-0.316**	-0.586***	-0.549***	-0.615***	-0.578***	-0.514***	-0.413***	-0.551***	-0.437***
1 - 2pm	C	-0.392***	-0.317**	-0.325**	-0.327**	-0.231	-0.481***	-0.525***	-0.508***	-0.504***	-0.359**	-0.446**	-0.487***	-0.294**
	A	-0.431***	-0.367***	-0.391***	-0.296**	-0.332***	-0.506***	-0.506***	-0.552***	-0.522***	-0.421***	-0.432***	-0.526***	-0.351***
2 - 3pm	C	-0.270**	-0.202	-0.220	-0.240	-0.185	-0.352**	-0.354**	-0.330**	-0.338**	-0.277*	-0.351*	-0.287*	
	A	-0.308***	-0.261**	-0.210	-0.278**	-0.278**	-0.360***	-0.318**	-0.372***	-0.351***	-0.348***	-0.354***	-0.328***	-0.229**
3 - 4pm	C	-0.253**	-0.235*	-0.234	-0.282*	-0.174	-0.327**	-0.380**	-0.284*	-0.275*	-0.174	-0.282	-0.300*	-0.144
	A	-0.296***	-0.300***	-0.308**	-0.255*	-0.276**	-0.348***	-0.348***	-0.329**	-0.293**	-0.249**	-0.284**	-0.348***	-0.206**
4 - 5pm	C	-0.315**	-0.179	-0.162	-0.312**	-0.234	-0.396**	-0.497***	-0.416***	-0.411**	-0.275*	-0.235	-0.277*	-0.122
	A	-0.362***	-0.252**	-0.243**	-0.292**	-0.338***	-0.429***	-0.472***	-0.468***	-0.433***	-0.345***	-0.238**	-0.329***	-0.188*
5 - 6pm	C	-0.268**	-0.136	-0.0408	-0.110	-0.211	-0.453***	-0.500***	-0.355**	-0.358**	-0.240	-0.199	-0.268*	-0.118
	A	-0.319***	-0.201*	-0.119	-0.0936	-0.323***	-0.492***	-0.493***	-0.415***	-0.386***	-0.323**	-0.202	-0.318**	-0.180*
6 - 7pm	C	-0.194	-0.0915	-0.0106	-0.0660	-0.208	-0.426***	-0.489***	-0.393**	-0.357**	-0.144	-0.174	-0.243	-0.0630
	A	-0.244**	-0.153	-0.0839	-0.0414	-0.317**	-0.468***	-0.485***	-0.453***	-0.395***	-0.226*	-0.180	-0.284**	-0.122
7 - 8pm	C	-0.149	-0.0548	-0.103	-0.0701	-0.267*	-0.280*	-0.219	-0.236	-0.0395	-0.209	-0.231	-0.0159	
	A	-0.195**	-0.117	-0.116	-0.0811	-0.186	-0.296**	-0.267**	-0.274**	-0.268**	-0.121	-0.211*	-0.269**	-0.0698
8 - 9pm	C	-0.137	-0.0816	-0.131	0.0140	-0.102	-0.0729	-0.145	-0.195	-0.132	-0.0322	-0.155	-0.204	-0.0355
	A	-0.179**	-0.147	-0.196*	-0.119	-0.102	-0.0879	-0.112	-0.245**	-0.152	-0.0986	-0.145	-0.243**	-0.0935
9 - 10pm	C	-0.100	-0.0840	-0.0986	-0.129	-0.0460	-0.0934	-0.175	-0.152	-0.0590	-0.0602	-0.150	-0.185	-0.0435
	A	-0.138	-0.148	-0.171*	-0.116	-0.153	-0.105	-0.141	-0.196*	-0.0686	-0.115	-0.126	-0.222**	-0.102
10 - 11pm	C	-0.0441	-0.0137	-0.0419	-0.0689	0.00491	-0.0840	-0.184	-0.124	-0.0755	-0.0663	-0.178	-0.195	-0.0239
	A	-0.0841	-0.0789	-0.117	-0.0556	-0.113	-0.102	-0.152	-0.171	-0.0819	-0.123	-0.157	-0.240**	-0.0853
11pm - Midnight	C	-0.0592	-0.0445	-0.0392	-0.0587	-0.00679	-0.0473	-0.115	-0.0607	-0.0958	-0.0516	-0.108	-0.137	-0.0222
	A	-0.110	-0.125	-0.130	-0.0565	-0.129	-0.0769	-0.0985	-0.109	-0.108	-0.117	-0.104	-0.204*	-0.0966
	N	42979662	4281113	3828788	4170381	3807952	4015978	3901014	3997958	3969912	3829244	1625110	1399704	4152508
	adj. R-sq	0.459	0.540	0.542	0.510	0.472	0.475	0.481	0.485	0.484	0.478	0.498	0.542	0.543

Table gives β_1 estimates from eq. (1) regressions
 * significant at $\alpha = 10\%$, ** significant at $\alpha = 5\%$, *** significant at $\alpha = 1\%$